

Outdoor

2026

Outdoor

2026

INDEX



SIZE INDEX



SURFACE
RANGE



IMAGE GALLERY



PRODUCT RANGE



TECHNICAL
SPECIFICATIONS



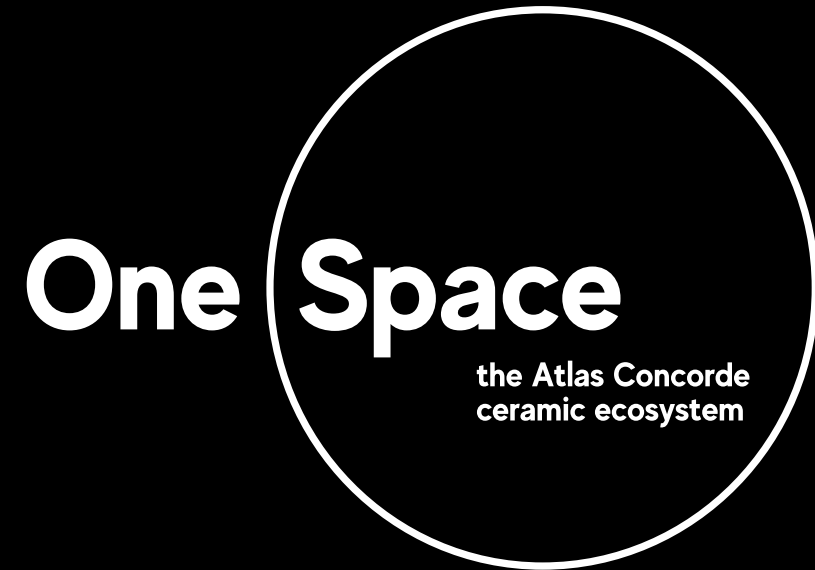

 **atlas concorde**

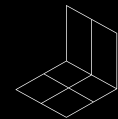

Surfaces and decors for indoor and outdoor

atlasPLAN

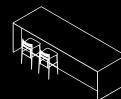

Large slabs for floor, wall and furniture

 **atlas concorde habitat**



Furniture

Index

↔ Size Index

↔ Surface Range

Image Gallery

- ↔ STONE LOOK
- ↔ CONCRETE LOOK
- ↔ WOOD LOOK
- ↔ MARBLE LOOK

Product Range

Stone Look

- ↔ BOOST ICOR
- ↔ BOOST MINERAL
- ↔ BOOST MIX
- ↔ BOOST STONE
- ↔ BRAVE
- ↔ LIMS
- ↔ NORDE
- ↔ NYRA

Concrete Look

- ↔ BOOST
- ↔ BOOST PRO
- ↔ BOOST BALANCE
- ↔ BOOST EXPRESSION
- ↔ BOOST NATURAL
- ↔ BOOST NATURAL PRO
- ↔ BOOST VISION

Wood Look

- ↔ LOG
- ↔ LOG CANSEI
- ↔ LOG SELECT
- ↔ ENTICE
- ↔ ETIC PRO
- ↔ EXENCE

Marble Look

- ↔ MARVEL MERAVIGLIA
- ↔ MARVEL X
- ↔ MARVEL T
- ↔ MARVEL TRAVERTINE

↔ Technical Specifications



A full range of solutions for outdoor

Outdoor Size Index

120x120

	154	BOOST	9/20 mm	Concrete Look
	156	BOOST BALANCE	9/20 mm	Concrete Look
	158	BOOST EXPRESSION	9/20 mm	Concrete Look
	140	BOOST ICOR	20 mm	Stone Look
	142	BOOST MINERAL	20 mm	Stone Look
	144	BOOST MIX	20 mm	Stone Look
	160	BOOST NATURAL	9/20 mm	Concrete Look
	160	BOOST NATURAL PRO	9/20 mm	Concrete Look
	154	BOOST PRO	9/20 mm	Concrete Look
	146	BOOST STONE	20 mm	Stone Look
	162	BOOST VISION	9/20 mm	Concrete Look
	152	NYRA	20 mm	Stone Look

60x120

	154	BOOST	20 mm	Concrete Look
	156	BOOST BALANCE	20 mm	Concrete Look
	158	BOOST EXPRESSION	9/20 mm	Concrete Look
	140	BOOST ICOR	9/20 mm	Stone Look
	142	BOOST MINERAL	9/20 mm	Stone Look
	144	BOOST MIX	20 mm	Stone Look
	160	BOOST NATURAL	9 mm	Concrete Look
	160	BOOST NATURAL PRO	9/20 mm	Concrete Look
	154	BOOST PRO	20 mm	Concrete Look
	146	BOOST STONE	9/20 mm	Stone Look
	162	BOOST VISION	20 mm	Concrete Look
	148	BRAVE	20 mm	Stone Look
	148	LIMS	20 mm	Stone Look
	164	LOG (deck)	20 mm	Wood Look
	174	MARVEL MERAUVIGLIA	20 mm	Marble Look
	176	MARVEL T	9/20 mm	Marble Look
	178	MARVEL TRAVERTINE	9/20 mm	Marble Look
	174	MARVEL X	20 mm	Marble Look
	150	NORDE	9/20 mm	Stone Look
	152	NYRA	9/20 mm	Stone Look

80x80

	154	BOOST	20 mm	Concrete Look
	158	BOOST EXPRESSION	20 mm	Concrete Look
	140	BOOST ICOR	20 mm	Stone Look
	154	BOOST PRO	20 mm	Concrete Look
	162	BOOST VISION	9 mm	Concrete Look
	150	NORDE	20 mm	Stone Look
	152	NYRA	20 mm	Stone Look

60x90

	142	BOOST MINERAL	20 mm	Stone Look
	150	NORDE	20 mm	Stone Look

60x60

	154	BOOST	20 mm	Concrete Look
	156	BOOST BALANCE	20 mm	Concrete Look
	158	BOOST EXPRESSION	20 mm	Concrete Look
	140	BOOST ICOR	20 mm	Stone Look
	142	BOOST MINERAL	9/20 mm	Stone Look
	144	BOOST MIX	20 mm	Stone Look
	160	BOOST NATURAL	20 mm	Concrete Look
	160	BOOST NATURAL PRO	20 mm	Concrete Look
	154	BOOST PRO	20 mm	Concrete Look
	146	BOOST STONE	20 mm	Stone Look
	162	BOOST VISION	20 mm	Concrete Look
	148	BRAVE	20 mm	Stone Look
	148	LIMS	20 mm	Stone Look
	150	NORDE	20 mm	Stone Look
	152	NYRA	9/20 mm	Stone Look

30x60

	140	BOOST ICOR	9 mm	Stone Look
	144	BOOST MIX	9 mm	Stone Look
	146	BOOST STONE	9 mm	Stone Look
	148	BRAVE	9 mm	Stone Look
	152	NYRA	9 mm	Stone Look

18,5x150

	172	EXENCE	9 mm	Wood Look
---	-----	--------	------	-----------

30x120

	170	ENTICE	20 mm	Wood Look
	170	ETIC PRO	20 mm	Wood Look
	172	EXENCE	20 mm	Wood Look
	164	LOG	20 mm	Wood Look
	168	LOG SELECT	20 mm	Wood Look

20x120

	170	ENTICE	9 mm	Wood Look
	164	LOG	9 mm	Wood Look
	166	LOG CANSEI	9 mm	Wood Look
	168	LOG SELECT	9 mm	Wood Look

INDEX



SIZE INDEX



SURFACE RANGE



IMAGE GALLERY



PRODUCT RANGE



TECHNICAL SPECIFICATIONS



Outdoor Porcelain Tiles Stone Look

≡ 9 mm Grip

≡ 20 mm Outdoor



INDEX



SIZE INDEX



SURFACE RANGE



STONE LOOK

CONCRETE LOOK

WOOD LOOK

MARBLE LOOK

IMAGE GALLERY



PRODUCT RANGE



TECHNICAL SPECIFICATIONS



Outdoor Porcelain Tiles Concrete Look

≡ 9 mm Grip

≡ 20 mm Outdoor

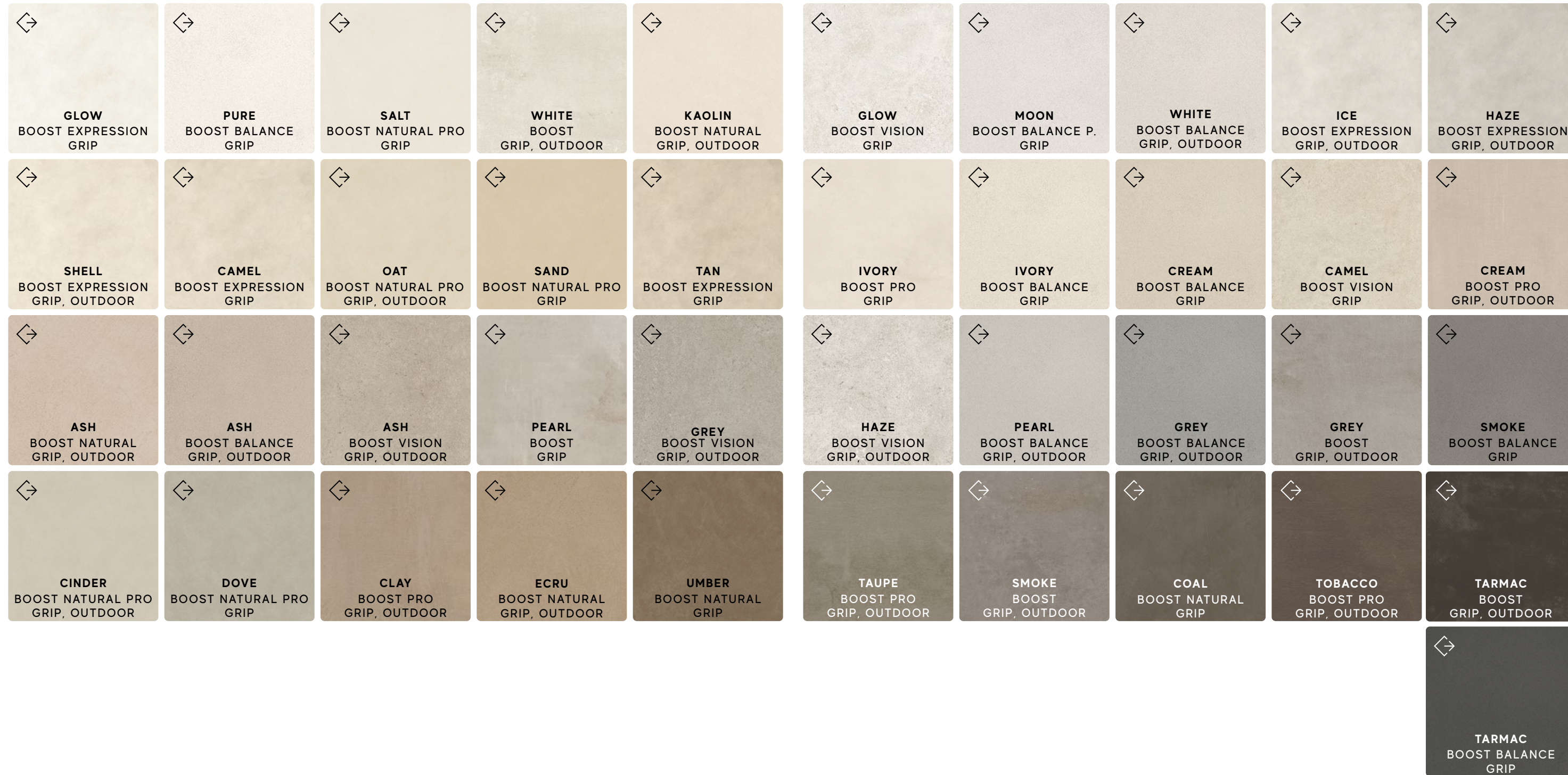

INDEX



SIZE INDEX



SURFACE RANGE



STONE LOOK

CONCRETE LOOK

WOOD LOOK

MARBLE LOOK

IMAGE GALLERY



PRODUCT RANGE



TECHNICAL SPECIFICATIONS



Outdoor Porcelain Tiles Wood Look

≡ 9 mm Grip

≡ 20 mm Outdoor

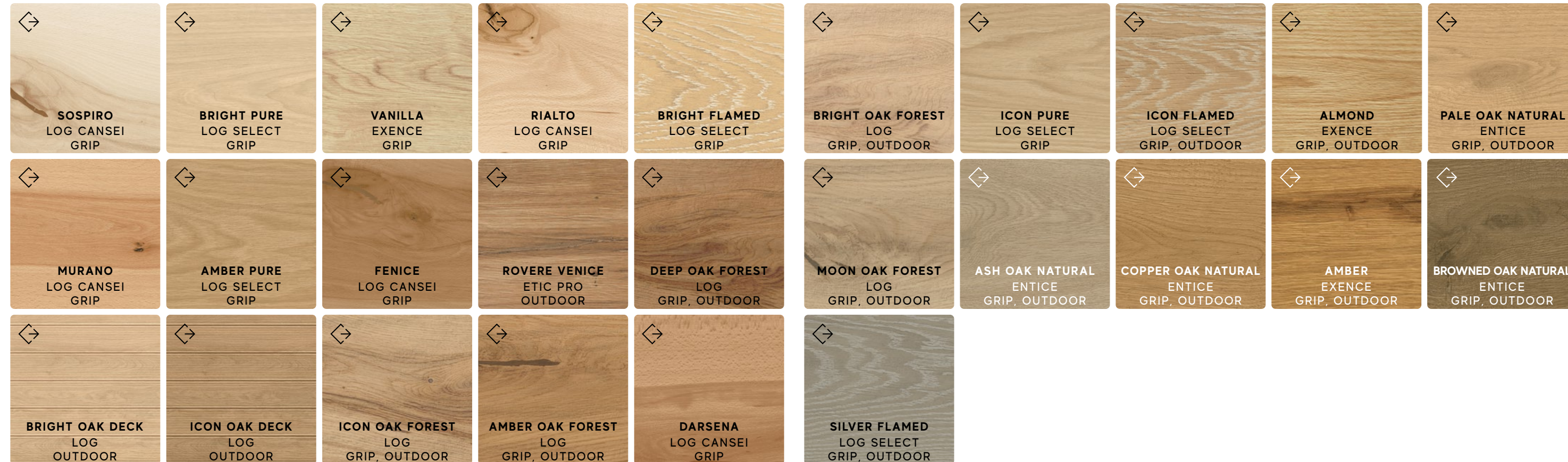

INDEX



SIZE INDEX



SURFACE RANGE



STONE LOOK
CONCRETE LOOK

WOOD LOOK
MARBLE LOOK

IMAGE GALLERY



PRODUCT RANGE



TECHNICAL SPECIFICATIONS



Outdoor Porcelain Tiles Marble Look

≡ 9 mm Grip

≡ 20 mm Outdoor, Hammered

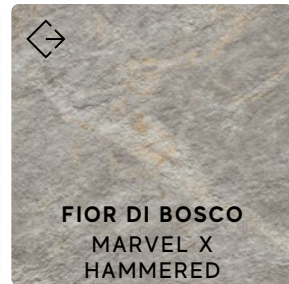
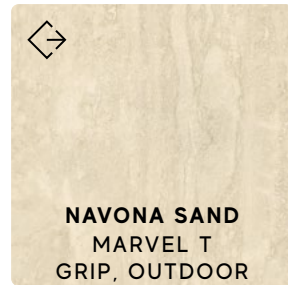
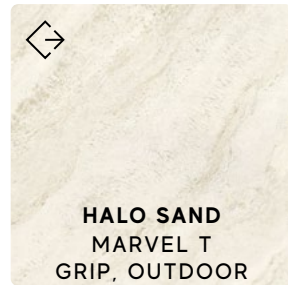
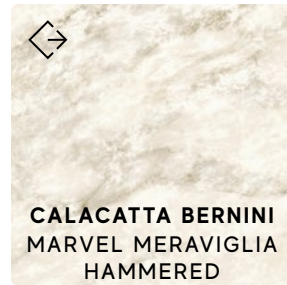
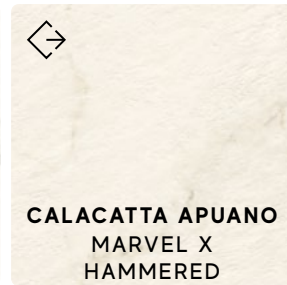

INDEX



SIZE INDEX



SURFACE RANGE



- STONE LOOK
- CONCRETE LOOK
- WOOD LOOK
- MARBLE LOOK

IMAGE GALLERY



PRODUCT RANGE



TECHNICAL SPECIFICATIONS





Image Gallery

- ◊ STONE LOOK
- ◊ CONCRETE LOOK
- ◊ WOOD LOOK
- ◊ MARBLE LOOK

INDEX



SIZE INDEX



SURFACE RANGE



IMAGE GALLERY



STONE LOOK
CONCRETE LOOK
WOOD LOOK
MARBLE LOOK

PRODUCT RANGE



TECHNICAL SPECIFICATIONS





INDEX



SIZE INDEX



SURFACE
RANGE



Stone Look

IMAGE GALLERY



STONE LOOK

CONCRETE LOOK

WOOD LOOK

MARBLE LOOK

PRODUCT RANGE



TECHNICAL
SPECIFICATIONS





FLOOR
 Outdoor Sensitech
Nyra Hay
 120x120 cm | 47¹/₄"x47¹/₄" ± 20 mm
Nyra Hay Bordo Piscina
 30x60 cm | 11³/₄"x23⁵/₈" ± 20 mm

FACADE
 Matte
Nyra Ambrosia
 120x278 cm | 47¹/₄"x109 1/2"

INDEX



SIZE INDEX



SURFACE RANGE



IMAGE GALLERY



STONE LOOK

CONCRETE LOOK

WOOD LOOK

MARBLE LOOK

PRODUCT RANGE



TECHNICAL SPECIFICATIONS





^
 FLOOR
 Outdoor Sensitech
Nyra Hay
 120x120 cm | 47¹/₄"x47¹/₄" ✂ 20 mm

>
 FLOOR
 Outdoor Sensitech
Nyra Hay
 120x120 cm | 47¹/₄"x47¹/₄" ✂ 20 mm
Nyra Hay
 60x120 cm | 23⁵/₈"x47¹/₄" ✂ 20 mm
Nyra Hay Bordo Piscina
 30x60 cm | 11³/₄"x23⁵/₈" ✂ 20 mm



INDEX



SIZE INDEX



SURFACE RANGE



IMAGE GALLERY



STONE LOOK

CONCRETE LOOK

WOOD LOOK

MARBLE LOOK

PRODUCT RANGE



TECHNICAL SPECIFICATIONS





FLOOR
 Outdoor Sensitech
Nyra Hay
 120x120 cm | 47¹/₄"x47¹/₄" ± 20 mm
Nyra Hay Bordo Piscina
 30x60 cm | 11³/₄"x23⁵/₈" ± 20 mm

WALL
 Matte
Nyra Ambrosia
 120x278 cm | 47¹/₄"x109¹/₂"

COLUMN
 Matte
Nyra Opus Hay
 32x32 cm | 12 5/8"x12 5/8"

INDEX



SIZE INDEX



SURFACE RANGE



IMAGE GALLERY



STONE LOOK

CONCRETE LOOK

WOOD LOOK

MARBLE LOOK

PRODUCT RANGE



TECHNICAL SPECIFICATIONS





<

OUTDOOR FLOOR
Outdoor Sensitech
Nyra Mist
60x120 cm | 23⁵/₈"x47¹/₄" ✂ 20 mm

INDOOR WALL
Matte
Nyra 3D Qube Star
50x120 cm | 19⁵/₈"x47¹/₄"

^

FLOOR
Outdoor Sensitech
Nyra Mist
60x120 cm | 23⁵/₈"x47¹/₄" ✂ 20 mm
Nyra Mist Bordo Piscina
30x60 cm | 11³/₄"x23⁵/₈" ✂ 20 mm

FACADE
Matte
Nyra Star
120x278 cm | 47¹/₄"x109¹/₂"
Matte Sensitech
Nyra Star
60x120 cm | 23⁵/₈"x47¹/₄"

INDEX



SIZE INDEX



SURFACE RANGE



IMAGE GALLERY



STONE LOOK

CONCRETE LOOK

WOOD LOOK

MARBLE LOOK

PRODUCT RANGE



TECHNICAL SPECIFICATIONS





FLOOR
Outdoor Sensitech
Nyra Star
120x120 cm | 47 1/4" x 47 1/4" ✕ 20 mm

FACADE
Matte
Nyra Star
120x278 cm | 47 1/4" x 109 1/2"

INDEX



SIZE INDEX



SURFACE
RANGE



IMAGE GALLERY



STONE LOOK

CONCRETE LOOK

WOOD LOOK

MARBLE LOOK

PRODUCT RANGE



TECHNICAL
SPECIFICATIONS





FLOOR
 Outdoor Sensitech
Nyra Star
 120x120 cm | 47¹/₄"x47¹/₄" ✂ 20 mm
Nyra Star Bordo Piscina
 30x60 cm | 11³/₄"x23⁵/₈" ✂ 20 mm

INDEX



SIZE INDEX



SURFACE RANGE



IMAGE GALLERY



STONE LOOK

CONCRETE LOOK

WOOD LOOK

MARBLE LOOK

PRODUCT RANGE



TECHNICAL SPECIFICATIONS





FLOOR
 Outdoor Sensitech
Boost Icor Oyster
 120x120 cm | 47¹/₄"x47¹/₄" ± 20 mm
Boost Icor Oyster Elemento L
 33x120 cm | 13"x47¹/₄" ± 20 mm
Boost Icor Oyster Alzata 20x120 SP
 20x120 cm | 7⁷/₈"x47¹/₄" ± 20 mm

INDEX



SIZE INDEX



SURFACE RANGE



IMAGE GALLERY



STONE LOOK

CONCRETE LOOK

WOOD LOOK

MARBLE LOOK

PRODUCT RANGE



TECHNICAL SPECIFICATIONS





^
 FLOOR
 Outdoor Sensitech
Boost Icor Oyster
 120x120 cm | 47¹/₄"x47¹/₄" ✂ 20 mm



>
 FLOOR
 Outdoor Sensitech
Boost Icor Oyster Pebble A+B
 59,5x59,5 cm | 23³/₈"x23³/₈" ✂ 20 mm

INDEX



SIZE INDEX



SURFACE RANGE



IMAGE GALLERY



STONE LOOK

CONCRETE LOOK

WOOD LOOK

MARBLE LOOK

PRODUCT RANGE



TECHNICAL SPECIFICATIONS



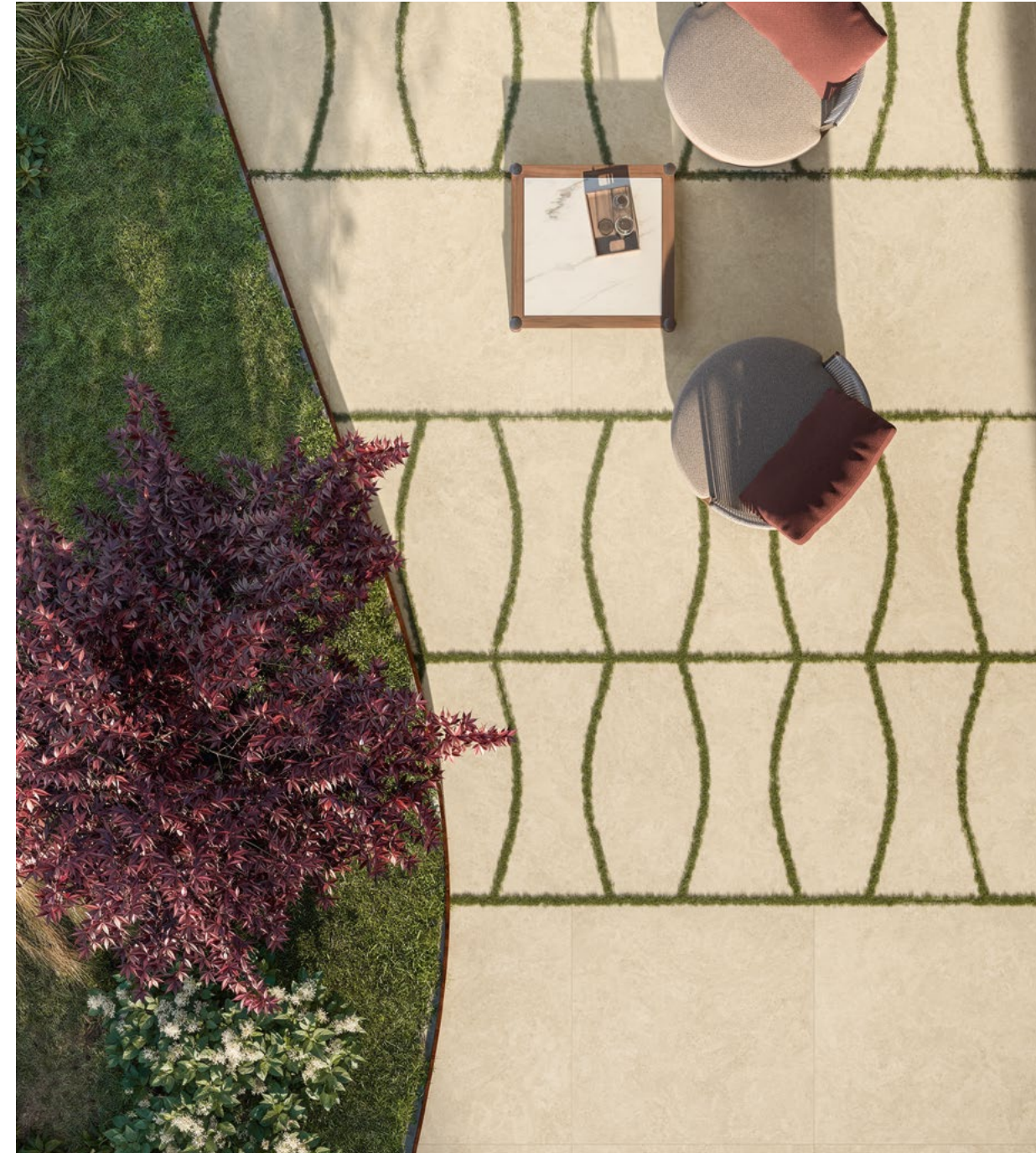

<

FLOOR
Outdoor Sensitech
Boost Icor Dune
120x120 cm | 47¹/₄"x47¹/₄" ± 20 mm

^

FLOOR
Outdoor Sensitech
Boost Icor Dune
120x120 cm | 47¹/₄"x47¹/₄" ± 20 mm
Boost Icor Dune Combo A
48,4x119 cm | 19¹/₈"x46⁷/₈" ± 20 mm
Boost Icor Dune Combo B
42,5x119 cm | 16³/₄"x46⁷/₈" ± 20 mm

INDEX



SIZE INDEX



SURFACE RANGE



IMAGE GALLERY



STONE LOOK

CONCRETE LOOK

WOOD LOOK

MARBLE LOOK

PRODUCT RANGE



TECHNICAL SPECIFICATIONS





WALL
Boost Mineral White Brick
 30x60 cm | 11³/₄"x47¹/₄"

FLOOR
 Outdoor Sensitech
Boost Mineral White
 120x120 cm | 47¹/₄"x47¹/₄" ✕ 20 mm
Boost Mineral White Elemento L
 33x120 cm | 13"x47¹/₄" ✕ 20 mm
Boost Mineral White Round
 33x120 cm | 13"x47¹/₄" ✕ 20 mm

INDEX



SIZE INDEX



SURFACE RANGE



IMAGE GALLERY



STONE LOOK

CONCRETE LOOK

WOOD LOOK

MARBLE LOOK

PRODUCT RANGE



TECHNICAL SPECIFICATIONS



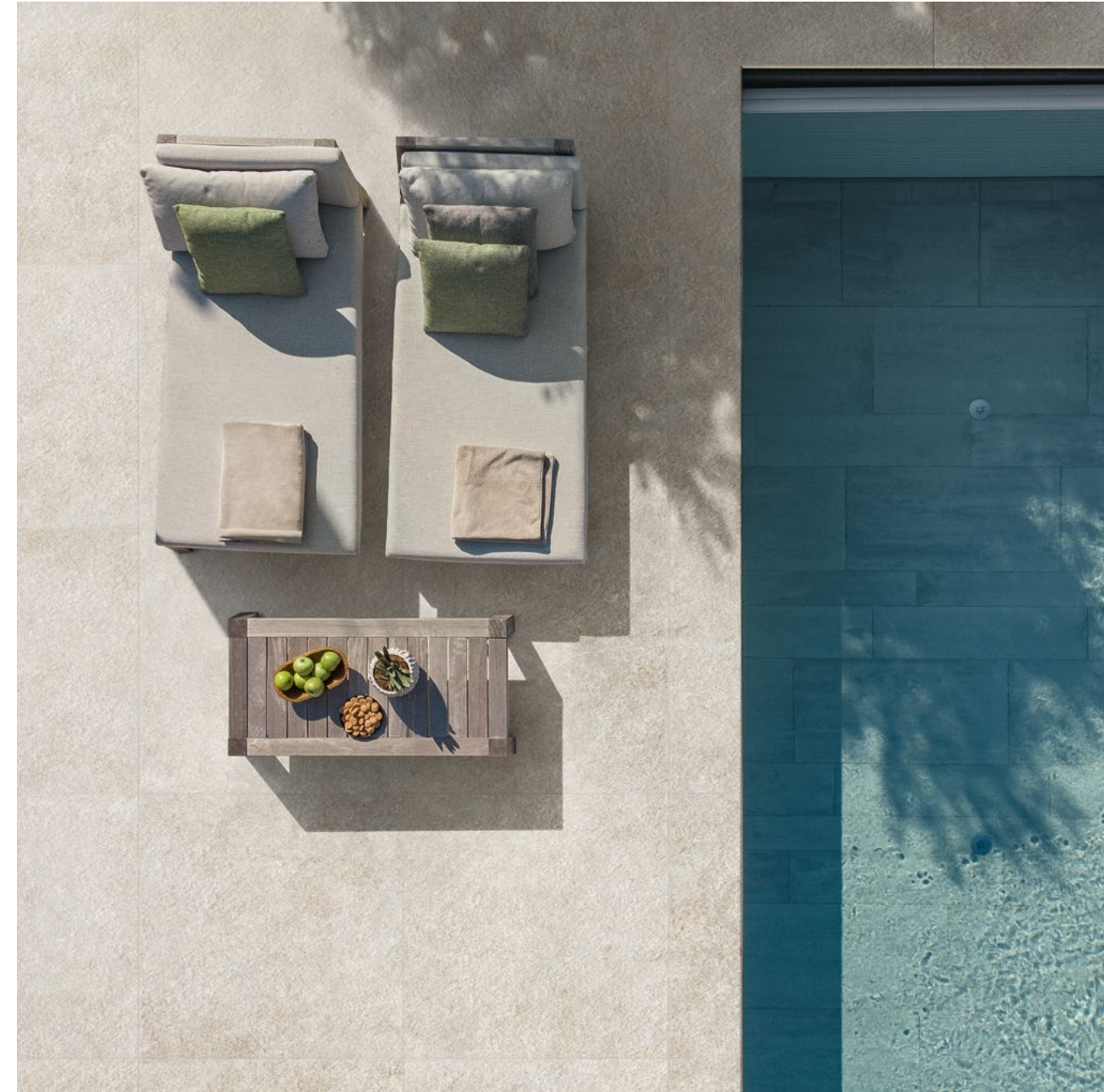

FLOOR (INDOOR)
 Matte Sensitech
Boost Mineral White
 120x120 cm | 47¹/₄"x47¹/₄"

FLOOR (OUTDOOR)
 Outdoor Sensitech
Boost Mineral White
 120x120 cm | 47¹/₄"x47¹/₄" ❌ 20 mm
Boost Mineral White Round
 33x120 cm | 13"x47¹/₄" ❌ 20 mm
Boost Mineral White Round Ang. DX/SX
 33x120 cm | 13"x47¹/₄" ❌ 20 mm
Boost Mineral White Elemento L
 33x120 cm | 13"x47¹/₄" ❌ 20 mm

INDEX



SIZE INDEX



SURFACE RANGE



IMAGE GALLERY



STONE LOOK

CONCRETE LOOK

WOOD LOOK

MARBLE LOOK

PRODUCT RANGE



TECHNICAL SPECIFICATIONS





FLOOR
 Outdoor Sensitech
Boost Stone Cream
 120x120 cm | 47¹/₄"x47¹/₄" ± 20 mm
Boost Stone Cream Round
 33x120 cm | 13"x47¹/₄" ± 20 mm
Boost Stone Cream Round Ang. DX/SX
 33x120 cm | 13"x47¹/₄" ± 20 mm
Boost Stone Cream Top
 33x120 cm | 13"x47¹/₄" ± 20 mm

WALL
Boost Stone Ivory
 120x278 cm | 47¹/₄"x109¹/₂"

INDEX



SIZE INDEX



SURFACE RANGE



IMAGE GALLERY



STONE LOOK

CONCRETE LOOK

WOOD LOOK

MARBLE LOOK

PRODUCT RANGE



TECHNICAL SPECIFICATIONS





FLOOR

Outdoor Sensitech

Boost Stone Cream
120x120 cm | 47 1/4" x 47 1/4" ✕ 20 mm

Boost Stone Cream Round
33x120 cm | 13" x 47 1/4" ✕ 20 mm

WALL

Boost Stone Ivory
120x278 cm | 47 1/4" x 109 1/2"



INDEX



SIZE INDEX



SURFACE RANGE



IMAGE GALLERY



STONE LOOK

CONCRETE LOOK

WOOD LOOK

MARBLE LOOK

PRODUCT RANGE



TECHNICAL SPECIFICATIONS





FLOOR
Outdoor Sensitech
Norde Oro
60x120 cm | 23⁵/₈"x47³/₄" ± 20 mm

INDEX



SIZE INDEX



SURFACE
RANGE



IMAGE GALLERY



STONE LOOK

CONCRETE LOOK

WOOD LOOK

MARBLE LOOK

PRODUCT RANGE



TECHNICAL
SPECIFICATIONS





<

FLOOR
 Outdoor Sensitech
Norde Oro Path A+B
 54x54 cm | 21¹/₄"x21¹/₄" ❄️ 20 mm
Norde Oro Path C
 55x109 cm | 21⁵/₈"x42⁷/₈" ❄️ 20 mm

^

FLOOR
 Grip Sensitech
Norde Oro Composizione Palladiana Grip
 Kit 8 m² | 8 sqm Kit

INDEX



SIZE INDEX



SURFACE RANGE



IMAGE GALLERY



STONE LOOK

CONCRETE LOOK

WOOD LOOK

MARBLE LOOK

PRODUCT RANGE



TECHNICAL SPECIFICATIONS





^
 FLOOR
 Outdoor Sensitech
Boost Mix Pearl
 120x120 cm | 47 1/4" x 47 1/4" ± 20 mm

WALL
 Matte
Boost Smoke
 120x278 cm | 47 1/4" x 109 1/2"



>
 FLOOR
 Outdoor Sensitech
Boost Mix Pearl
 120x120 cm | 47 1/4" x 47 1/4" ± 20 mm

INDEX



SIZE INDEX



SURFACE RANGE



IMAGE GALLERY



STONE LOOK

CONCRETE LOOK

WOOD LOOK

MARBLE LOOK

PRODUCT RANGE



TECHNICAL SPECIFICATIONS





<
 FLOOR
 Outdoor Sensitech
Boost Mineral Grey
 120x120 cm | 47¹/₄"x47¹/₄" ✂ 20 mm

^
 FLOOR
 Grip Sensitech
Boost Mineral White Grip
 60x120 cm | 23⁵/₈"x47¹/₄"

INDEX



SIZE INDEX



SURFACE RANGE



IMAGE GALLERY



STONE LOOK

CONCRETE LOOK

WOOD LOOK

MARBLE LOOK

PRODUCT RANGE



TECHNICAL SPECIFICATIONS





INDEX



SIZE INDEX



SURFACE
RANGE



Concrete Look

IMAGE GALLERY



STONE LOOK

CONCRETE LOOK

WOOD LOOK

MARBLE LOOK

PRODUCT RANGE



TECHNICAL
SPECIFICATIONS





FLOOR
Matte Sensitech
Boost Vision Haze Grip
120x120 cm | 47 1/4" x 47 1/4"

INDEX



SIZE INDEX



SURFACE
RANGE



IMAGE GALLERY



STONE LOOK

CONCRETE LOOK

WOOD LOOK

MARBLE LOOK

PRODUCT RANGE



TECHNICAL
SPECIFICATIONS





FLOOR

Outdoor Sensitech

Boost Vision Grey
120x120 cm | 47 1/4" x 47 1/4" ✂ 20 mm

Log Icon Oak Deck
60x120 cm | 23 5/8" x 47 1/4" ✂ 20 mm

FACADE
Matte

Boost Vision Camel
120x278 cm | 47 1/4" x 109 1/2"

INDEX



SIZE INDEX



SURFACE
RANGE



IMAGE GALLERY



STONE LOOK

CONCRETE LOOK

WOOD LOOK

MARBLE LOOK

PRODUCT RANGE



TECHNICAL
SPECIFICATIONS





FLOOR
 Outdoor Sensitech
Boost Vision Grey
 120x120 cm | 47¹/₄"x47¹/₄" ✕ 20 mm
Log Icon Oak Deck
 60x120 cm | 23³/₈"x47¹/₄" ✕ 20 mm
Boost Vision Grey Round
 33x120 cm | 13"x47¹/₄"

FACADE
 Matte
Boost Vision Grey
 120x278 cm | 47¹/₄"x109¹/₂"
Boost Vision Corten
 120x278 cm | 47¹/₄"x109¹/₂"

INDEX



SIZE INDEX



SURFACE RANGE



IMAGE GALLERY



- STONE LOOK
- CONCRETE LOOK
- WOOD LOOK
- MARBLE LOOK

PRODUCT RANGE



TECHNICAL SPECIFICATIONS





^
 FLOOR
 Outdoor Sensitech
Boost Vision Grey
 120x120 cm | 47¹/₄"x47¹/₄" ± 20 mm
Boost Vision Grey Round
 33x120 cm | 13"x47¹/₄"

>
 FLOOR
 Outdoor Sensitech
Boost Vision Grey
 120x120 cm | 47¹/₄"x47¹/₄" ± 20 mm
Boost Vision Grey Round
 33x120 cm | 13"x47¹/₄"

FACADE
 Matte
Boost Vision Grey
 120x278 cm | 47¹/₄"x109¹/₂"
Boost Vision Corten
 120x278 cm | 47¹/₄"x109¹/₂"



INDEX



SIZE INDEX



SURFACE RANGE



IMAGE GALLERY



STONE LOOK

CONCRETE LOOK

WOOD LOOK

MARBLE LOOK

PRODUCT RANGE



TECHNICAL SPECIFICATIONS





<
 FLOOR
 Outdoor Sensitech
Boost Vision Ash Grip
 120x120 cm | 47¹/₄"x47¹/₄"

FACADE
 Matte
Boost Vision Glow
 120x278 cm | 47¹/₄"x109¹/₂"

^
 FLOOR
 Matte Sensitech
Boost Vision Ash Grip
 120x120 cm | 47¹/₄"x47¹/₄"

INDEX



SIZE INDEX



SURFACE RANGE



IMAGE GALLERY



- STONE LOOK
- CONCRETE LOOK
- WOOD LOOK
- MARBLE LOOK

PRODUCT RANGE



TECHNICAL SPECIFICATIONS





^
 FLOOR
 Outdoor Sensitech
Boost Vision Ash
 120x120 cm | 47 1/4" x 47 1/4" ± 20 mm

FURNITURE
 Matte
Boost Vision Corten
 120x278 cm | 47 1/4" x 109 1/2"

>
 FLOOR
 Outdoor Sensitech
Boost Vision Ash
 120x120 cm | 47 1/4" x 47 1/4" ± 20 mm

INDOOR FLOOR
 Matte Sensitech
Boost Vision Ash
 120x120 cm | 47 1/4" x 47 1/4" ± 20 mm

FACADE
 Matte
Boost Vision Grey
 120x278 cm | 47 1/4" x 109 1/2"
Boost Vision Corten
 120x278 cm | 47 1/4" x 109 1/2"



INDEX



SIZE INDEX



SURFACE RANGE



IMAGE GALLERY



STONE LOOK

CONCRETE LOOK

WOOD LOOK

MARBLE LOOK

PRODUCT RANGE



TECHNICAL SPECIFICATIONS





FLOOR
Outdoor Sensitech
Boost Expression Haze
120x120 cm | 47¹/₄"x47¹/₄" ± 20 mm

WALL
Boost Expression Haze
120x278 cm | 47¹/₄"x109¹/₂"

OUTDOOR COUNTER
Boost Expression Haze
120x278 cm | 47¹/₄"x109¹/₂"

INDEX



SIZE INDEX



SURFACE
RANGE



IMAGE GALLERY



STONE LOOK
CONCRETE LOOK
WOOD LOOK
MARBLE LOOK

PRODUCT RANGE



TECHNICAL
SPECIFICATIONS





FLOOR
Outdoor Sensitech
Boost Expression Haze
120x120 cm | 47¹/₄"x47¹/₄" ✂ 20 mm

WALL
Boost Expression Haze
120x278 cm | 47¹/₄"x109¹/₂"

OUTDOOR COUNTER
Boost Expression Haze
120x278 cm | 47¹/₄"x109¹/₂"

INDEX



SIZE INDEX



SURFACE RANGE



IMAGE GALLERY



STONE LOOK

CONCRETE LOOK

WOOD LOOK

MARBLE LOOK

PRODUCT RANGE



TECHNICAL SPECIFICATIONS





FLOOR
Outdoor Sensitech
Boost Expression Ice
120x120 cm | 47 1/4" x 47 1/4" ✂ 20 mm
Boost Expression Ice Elemento L
33x120 cm | 13" x 47 1/4" ✂ 20 mm

INDEX



SIZE INDEX



SURFACE
RANGE



IMAGE GALLERY



STONE LOOK

CONCRETE LOOK

WOOD LOOK

MARBLE LOOK

PRODUCT RANGE



TECHNICAL
SPECIFICATIONS





FLOOR
 Outdoor Sensitech
Boost Expression Shell
 120x120 cm | 47¹/₄"x47¹/₄" ± 20 mm
Boost Expression Shell Elemento L
 33x120 cm | 13"x47¹/₄" ± 20 mm

INDEX



SIZE INDEX



SURFACE RANGE



IMAGE GALLERY



STONE LOOK

CONCRETE LOOK

WOOD LOOK

MARBLE LOOK

PRODUCT RANGE



TECHNICAL SPECIFICATIONS





FLOOR
 Outdoor Sensitech
Boost Balance Pearl
 120x120 cm | 47 1/4" x 47 1/4" ± 20 mm
Boost Balance Pearl Round
 33x120 cm | 13" x 47 1/4" ± 20 mm
Boost Balance Pearl Elemento L
 33x120 cm | 13" x 47 1/4" ± 20 mm

INDEX



SIZE INDEX



SURFACE RANGE



IMAGE GALLERY



STONE LOOK

CONCRETE LOOK

WOOD LOOK

MARBLE LOOK

PRODUCT RANGE



TECHNICAL SPECIFICATIONS





FLOOR
Outdoor Sensitech
Boost Balance Pearl
120x120 cm | 47 1/4" x 47 1/4" ±20 mm

WALL
Boost Balance Pearl
120x278 cm | 47 1/4" x 109 1/2"

INDEX



SIZE INDEX



SURFACE
RANGE



IMAGE GALLERY



- STONE LOOK
- CONCRETE LOOK
- WOOD LOOK
- MARBLE LOOK

PRODUCT RANGE



TECHNICAL
SPECIFICATIONS





^
 FLOOR
 Outdoor Sensitech
Boost Balance Pearl
 120x120 cm | 47¹/₄"x47¹/₄" ±20 mm
Boost Balance Pearl Elemento L
 33x120 cm | 13"x47¹/₄" ±20 mm



>
 FLOOR
 Outdoor Sensitech
Boost Balance Ash
 120x120 cm | 47¹/₄"x47¹/₄" ±20 mm

INDEX



SIZE INDEX



SURFACE RANGE



IMAGE GALLERY



STONE LOOK

CONCRETE LOOK

WOOD LOOK

MARBLE LOOK

PRODUCT RANGE



TECHNICAL SPECIFICATIONS





FLOOR (OUTDOOR)
 Outdoor Sensitech
Boost Natural Pro Cinder
 120x120 cm | 47¹/₄"x47¹/₄" ❌ 20 mm
Boost Natural Pro Cinder Elemento L
 33x120 cm | 13"x47¹/₄" ❌ 20 mm
Boost Natural Pro Cinder Alzata
 20x120 cm | 7⁷/₈"x47¹/₄" ❌ 20 mm

FLOOR (INDOOR)
 Matte Sensitech
Boost Natural Pro Cinder
 120x120 cm | 47¹/₄"x47¹/₄"

INDEX



SIZE INDEX



SURFACE RANGE



IMAGE GALLERY



- STONE LOOK
- CONCRETE LOOK
- WOOD LOOK
- MARBLE LOOK

PRODUCT RANGE



TECHNICAL SPECIFICATIONS





FLOOR
 Outdoor Sensitech
Boost White
 120x120 cm | 47 1/4" x 47 1/4" ✂ 20 mm
Boost White Round
 33x120 cm | 13" x 47 1/4" ✂ 20 mm
Boost White Round Ang. Dx/Sx
 33x120 cm | 13" x 47 1/4" ✂ 20 mm
 Grip Sensitech
Boost White Grip
 120x120 cm | 47 1/4" x 47 1/4"

INDEX



SIZE INDEX



SURFACE RANGE



IMAGE GALLERY



STONE LOOK

CONCRETE LOOK

WOOD LOOK

MARBLE LOOK

PRODUCT RANGE



TECHNICAL SPECIFICATIONS





FLOOR
 Outdoor Sensitech
Boost White
 120x120 cm | 47 1/4" x 47 1/4" ± 20 mm
Boost White Round
 33x120 cm | 13" x 47 1/4" ± 20 mm
Boost White Round Ang. Dx/Sx
 33x120 cm | 13" x 47 1/4" ± 20 mm
 Grip Sensitech
Boost White Grip
 120x120 cm | 47 1/4" x 47 1/4"



INDEX 

SIZE INDEX 



SURFACE RANGE 

IMAGE GALLERY 

- STONE LOOK
- CONCRETE LOOK
- WOOD LOOK
- MARBLE LOOK

PRODUCT RANGE 

TECHNICAL SPECIFICATIONS 



FLOOR
 Outdoor Sensitech
Boost Pro Clay
 120x120 cm | 47 1/4" x 47 1/4" ± 20 mm
Boost Pro Clay Elemento L
 33x120 cm | 13" x 47 1/4" ± 20 mm
Boost Pro Clay Round
 33x120 cm | 13" x 47 1/4" ± 20 mm
Boost Pro Clay Round Round Ang. DX/SX
 33x120 cm | 13" x 47 1/4" ± 20 mm

INDEX



SIZE INDEX



SURFACE RANGE



IMAGE GALLERY



STONE LOOK

CONCRETE LOOK

WOOD LOOK

MARBLE LOOK

PRODUCT RANGE



TECHNICAL SPECIFICATIONS





FLOOR
 Outdoor Sensitech
 Boost Natural Ecrú
 120x120 cm | 47 1/4" x 47 1/4" ±20 mm
 Boost Natural Ecrú Elemento L
 33x120 cm | 13" x 47 1/4" ±20 mm
 Boost Natural Ecrú Alzata
 20x120 cm | 7 7/8" x 47 1/4" ±20 mm

WALL
 Boost Natural Umber
 120x278 cm | 47 1/4" x 109 1/2"

INDEX



SIZE INDEX



SURFACE RANGE



IMAGE GALLERY



STONE LOOK

CONCRETE LOOK

WOOD LOOK

MARBLE LOOK

PRODUCT RANGE



TECHNICAL SPECIFICATIONS





INDEX



SIZE INDEX



SURFACE RANGE



Wood Look

IMAGE GALLERY



STONE LOOK
CONCRETE LOOK

WOOD LOOK
MARBLE LOOK

PRODUCT RANGE



TECHNICAL SPECIFICATIONS





FLOOR
Grip Sensitech
Log Select Bright Pure Grip
20x120 cm | 7⁷/₈" x 47¹/₄"

INDEX



SIZE INDEX



SURFACE
RANGE



IMAGE GALLERY



STONE LOOK
CONCRETE LOOK

WOOD LOOK

MARBLE LOOK

PRODUCT RANGE



TECHNICAL
SPECIFICATIONS





FLOOR
 Outdoor Sensitech
Log Select Icon Flamed
 30x120 cm | 11³/₄"x47¹/₄" ± 20 mm

WALL
 Matte Sensitech
Log Select Icon Flamed
 20x120 cm | 7⁷/₈"x47¹/₄"

ATLAS PLAN
 Hammered
Ambrosia
 160x320 cm | 63"x126"



INDEX



SIZE INDEX



SURFACE RANGE



IMAGE GALLERY



STONE LOOK
CONCRETE LOOK

WOOD LOOK

MARBLE LOOK

PRODUCT RANGE



TECHNICAL SPECIFICATIONS





FLOOR
 Outdoor Sensitech
Log Select Silver Flamed
 30x120 cm | 11³/₄"x47¹/₄" ✂ 20 mm

WALL
 Matte Sensitech
Log Select Silver Flamed
 20x120 cm | 7⁷/₈"x47¹/₄"
 Matte
Vest Cotton
 120x278 cm | 47¹/₄"x109¹/₂"

INDEX



SIZE INDEX



SURFACE RANGE



IMAGE GALLERY



STONE LOOK
CONCRETE LOOK

WOOD LOOK

MARBLE LOOK

PRODUCT RANGE



TECHNICAL SPECIFICATIONS





FLOOR
Outdoor Sensitech
Log Icon Oak Deck
60x120 cm | 23⁵/₈"x47¹/₂" ✂ 20 mm
Log Icon Oak Forest
30x120 cm | 11³/₄"x47¹/₄" ✂ 20 mm

WALL
Boost Balance White
120x278 cm | 47¹/₄"x109³/₄"

INDEX



SIZE INDEX



SURFACE RANGE



IMAGE GALLERY



STONE LOOK
CONCRETE LOOK

WOOD LOOK

MARBLE LOOK

PRODUCT RANGE



TECHNICAL SPECIFICATIONS





FLOOR
 Outdoor Sensitech
Log Icon Oak Deck
 60x120 cm | 23⁵/₈"x47¹/₄" ± 20 mm
Log Icon Oak Forest
 30x120 cm | 11³/₄"x47¹/₄" ± 20 mm

WALL
Boost Balance White
 120x278 cm | 47¹/₄"x109¹/₂"



INDEX



SIZE INDEX



SURFACE RANGE



IMAGE GALLERY



STONE LOOK
CONCRETE LOOK

WOOD LOOK

MARBLE LOOK

PRODUCT RANGE



TECHNICAL SPECIFICATIONS





<

FLOOR (OUTDOOR)
Outdoor Sensitech
Log Bright Oak Forest
30x120 cm | 11³/₄"x47¹/₄" ❌ 20 mm
Log Bright Oak Forest Elemento L
30x120 cm | 11³/₄"x47¹/₄" ❌ 20 mm

^

FLOOR (INDOOR)
Matte Sensitech
Log Bright Oak
20x120 cm | 7⁷/₈"x47¹/₄"

FLOOR (OUTDOOR)
Outdoor Sensitech
Log Bright Oak Forest
30x120 cm | 11³/₄"x47¹/₄" ❌ 20 mm
Log Bright Oak Forest Elemento L
30x120 cm | 11³/₄"x47¹/₄" ❌ 20 mm

INDEX



SIZE INDEX



SURFACE RANGE



IMAGE GALLERY



STONE LOOK
CONCRETE LOOK

WOOD LOOK

MARBLE LOOK

PRODUCT RANGE



TECHNICAL SPECIFICATIONS





^
 FLOOR
 Outdoor Sensitech
Log Bright Oak Forest
 30x120 cm | 11³/₄"x47¹/₄" ✂ 20 mm

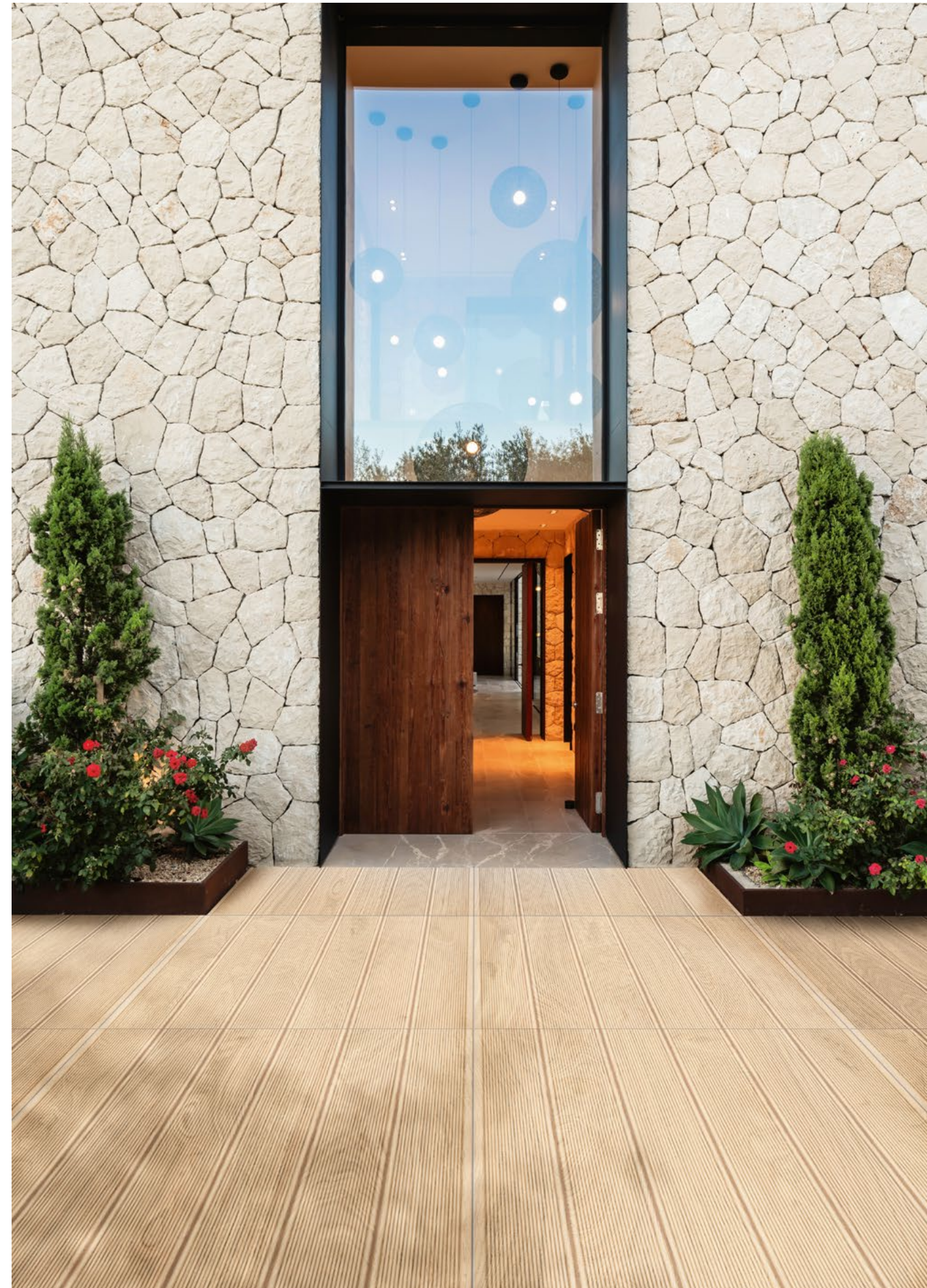

>
 FLOOR
 Outdoor Sensitech
Log Bright Oak Deck
 60x120 cm | 23⁵/₈"x47¹/₄" ✂ 20 mm

INDEX



SIZE INDEX



SURFACE RANGE



IMAGE GALLERY



STONE LOOK
CONCRETE LOOK

WOOD LOOK

MARBLE LOOK

PRODUCT RANGE



TECHNICAL SPECIFICATIONS





FLOOR
 Grip Sensitech
Log Cansei Murano Grip
 20x120 cm | 7⁷/₈"x47¹/₄"

WALL
 Matte Sensitech
Log Cansei Murano Riga
 18,5x150 cm | 7¹/₄"x59"

INDEX



SIZE INDEX



SURFACE RANGE



IMAGE GALLERY



STONE LOOK
CONCRETE LOOK

WOOD LOOK

MARBLE LOOK

PRODUCT RANGE



TECHNICAL SPECIFICATIONS





FLOOR
 Outdoor Sensitech
 Entice Browned Oak Natural
 30x120 cm | 11³/₄"x47¹/₄" ✂ 20 mm
 Entice Browned Oak Natural Elemento L
 30x120 cm | 11³/₄"x47¹/₄" ✂ 20 mm
 Entice Browned Oak Natural Round
 30x120 cm | 11³/₄"x47¹/₄" ✂ 20 mm

INDEX



SIZE INDEX



SURFACE RANGE



IMAGE GALLERY



STONE LOOK
CONCRETE LOOK

WOOD LOOK

MARBLE LOOK

PRODUCT RANGE



TECHNICAL SPECIFICATIONS





^
FLOOR
 Outdoor Sensitech
Exence Almond
 30x120 cm | 11³/₄"x47¹/₄" ❄️ 20 mm
Exence Almond Round
 30x120 cm | 11³/₄"x47¹/₄" ❄️ 20 mm

Exence Almond Round Ang. Dx/Sx
 30x120 cm | 11³/₄"x47¹/₄" ❄️ 20 mm
Exence Almond Alzata
 30x120 cm | 11³/₄"x47¹/₄" ❄️ 20 mm
Boost Grey
 120x120 cm | 47¹/₄"x47¹/₄" ❄️ 20 mm



>
FLOOR
 Outdoor Sensitech
Etic Pro Rovere Venice
 30x120 cm | 11³/₄"x47¹/₄" ❄️ 20 mm

INDEX



SIZE INDEX



SURFACE RANGE



IMAGE GALLERY



STONE LOOK
 CONCRETE LOOK

WOOD LOOK

MARBLE LOOK

PRODUCT RANGE



TECHNICAL SPECIFICATIONS





INDEX



SIZE INDEX



SURFACE
RANGE



Marble Look

IMAGE GALLERY



STONE LOOK
CONCRETE LOOK
WOOD LOOK
MARBLE LOOK

PRODUCT RANGE



TECHNICAL
SPECIFICATIONS





FLOOR
 Outdoor Sensitech
Marvel T Romano Sand
 60x120 cm | 23⁵/₈"x47¹/₄" ± 20 mm

WALL
 Matte Sensitech
Marvel T Romano Sand
 60x120 cm | 23⁵/₈"x47¹/₄"

INDEX



SIZE INDEX



SURFACE RANGE



IMAGE GALLERY



- STONE LOOK
- CONCRETE LOOK
- WOOD LOOK
- MARBLE LOOK

PRODUCT RANGE



TECHNICAL SPECIFICATIONS





FLOOR
Outdoor Sensitech
Marvel T Romano Sand
60x120 cm | 23⁵/₈"x47¹/₄" ± 20 mm

WALL
Matte Sensitech
Marvel T Romano Sand
60x120 cm | 23⁵/₈"x47¹/₄"

INDEX



SIZE INDEX



SURFACE RANGE



IMAGE GALLERY



- STONE LOOK
- CONCRETE LOOK
- WOOD LOOK
- MARBLE LOOK

PRODUCT RANGE



TECHNICAL SPECIFICATIONS





FLOOR
 Grip Sensitech
Marvel T Romano Sand
 60x120 cm | 23⁵/₈"x47¹/₄"

WALL
 Matte
Marvel T Romano Sand
 120x278 cm | 47¹/₄"x109¹/₂"

INDEX



SIZE INDEX



SURFACE RANGE



IMAGE GALLERY



- STONE LOOK
- CONCRETE LOOK
- WOOD LOOK
- MARBLE LOOK

PRODUCT RANGE



TECHNICAL SPECIFICATIONS





FLOOR
 Outdoor Sensitech
Marvel T Halo Sand
 60x120 cm | 23⁵/₈"x47¹/₄" ± 20 mm

WALL
 Matte
Marvel T Halo Sand
 120x278 cm | 47¹/₄"x109¹/₂"

INDEX



SIZE INDEX



SURFACE RANGE



IMAGE GALLERY



- STONE LOOK
- CONCRETE LOOK
- WOOD LOOK
- MARBLE LOOK

PRODUCT RANGE



TECHNICAL SPECIFICATIONS





FLOOR
Outdoor Sensitech
Marvel T Halo Sand
60x120 cm | 23⁵/₈"x47¹/₄" ± 20 mm

WALL
Matte
Marvel T Halo Sand
120x278 cm | 47¹/₄"x109¹/₂"



INDEX



SIZE INDEX



SURFACE RANGE



IMAGE GALLERY



- STONE LOOK
- CONCRETE LOOK
- WOOD LOOK
- MARBLE LOOK

PRODUCT RANGE



TECHNICAL SPECIFICATIONS





FLOOR
Outdoor Sensitech
Navona Sand
60x120 cm | 23⁵/₈"x47¹/₄" ± 20 mm

WALL
Matte
Marvel T Stone Veil
120x278 cm | 47¹/₄"x109¹/₂"
Marvel T Navona White
120x278 cm | 47¹/₄"x109¹/₂"

INDEX



SIZE INDEX



SURFACE RANGE



IMAGE GALLERY



- STONE LOOK
- CONCRETE LOOK
- WOOD LOOK
- MARBLE LOOK

PRODUCT RANGE



TECHNICAL SPECIFICATIONS





FLOOR
Outdoor Sensitech
Marvel Travertine Sand Vein Cut
60x120 cm | 23⁵/₈"x47¹/₄" ❄️ 20 mm
Marvel Travertine White Vein Cut
60x120 cm | 23⁵/₈"x47¹/₄" ❄️ 20 mm

WALL
Marvel Travertine Sand Cross Cut
60x120 cm | 23⁵/₈"x47¹/₄"

INDEX



SIZE INDEX



SURFACE RANGE



IMAGE GALLERY



- STONE LOOK
- CONCRETE LOOK
- WOOD LOOK
- MARBLE LOOK

PRODUCT RANGE



TECHNICAL SPECIFICATIONS





FLOOR
 Outdoor Sensitech
Marvel Travertine Sand Vein Cut
 60x120 cm | 23⁵/₈"x47¹/₄" ✂ 20 mm
Marvel Travertine White Vein Cut
 60x120 cm | 23⁵/₈"x47¹/₄" ✂ 20 mm

WALL
Marvel Travertine Sand Cross Cut
 60x120 cm | 23⁵/₈"x47¹/₄"



INDEX



SIZE INDEX



SURFACE RANGE



IMAGE GALLERY



- STONE LOOK
- CONCRETE LOOK
- WOOD LOOK
- MARBLE LOOK

PRODUCT RANGE



TECHNICAL SPECIFICATIONS





FLOOR
 Grip Sensitech
Marvel Travertine Sand Cross Cut Grip
 60x120 cm | 23⁵/₈"x47¹/₄"
Marvel Travertine Sand Cross Cut
Elemento L Grip
 33x120 h 4 cm | 13"x47¹/₄" h 1⁵/₈"

FACADE
Marvel Travertine Sand Vein Cut
 60x120 cm | 23⁵/₈"x47¹/₄"

INDEX



SIZE INDEX



SURFACE RANGE



IMAGE GALLERY



- STONE LOOK
- CONCRETE LOOK
- WOOD LOOK
- MARBLE LOOK

PRODUCT RANGE



TECHNICAL SPECIFICATIONS





FLOOR
Outdoor Sensitech
Marvel Meraviglia Calacatta Bernini Hammered
60x120 cm | 23⁵/₈"x47¹/₄" ✂ 20 mm
Marvel Meraviglia Calacatta Bernini Hammered Round
33x120 cm | 13"x47¹/₄" ✂ 20 mm
Marvel Meraviglia Calacatta Bernini Hammered Elemento L
33x120 cm | 13"x47¹/₄" ✂ 20 mm

INDEX



SIZE INDEX



SURFACE RANGE



IMAGE GALLERY



STONE LOOK
CONCRETE LOOK
WOOD LOOK
MARBLE LOOK

PRODUCT RANGE



TECHNICAL SPECIFICATIONS





FLOOR (INDOOR)
Marvel Meraviglia Calacatta Bernini Polished
 120x240 cm | 47¹/₄"x94¹/₂"

FLOOR (OUTDOOR)
 Outdoor Sensitech
Marvel Meraviglia Calacatta Bernini Hammered
 60x120 cm | 23⁵/₈"x47¹/₄" ✂ 20 mm

WALL
Marvel Meraviglia Black Origin
 120x278 cm | 47¹/₄"x109¹/₂"

INDEX



SIZE INDEX



SURFACE RANGE



IMAGE GALLERY



- STONE LOOK
- CONCRETE LOOK
- WOOD LOOK
- MARBLE LOOK

PRODUCT RANGE



TECHNICAL SPECIFICATIONS



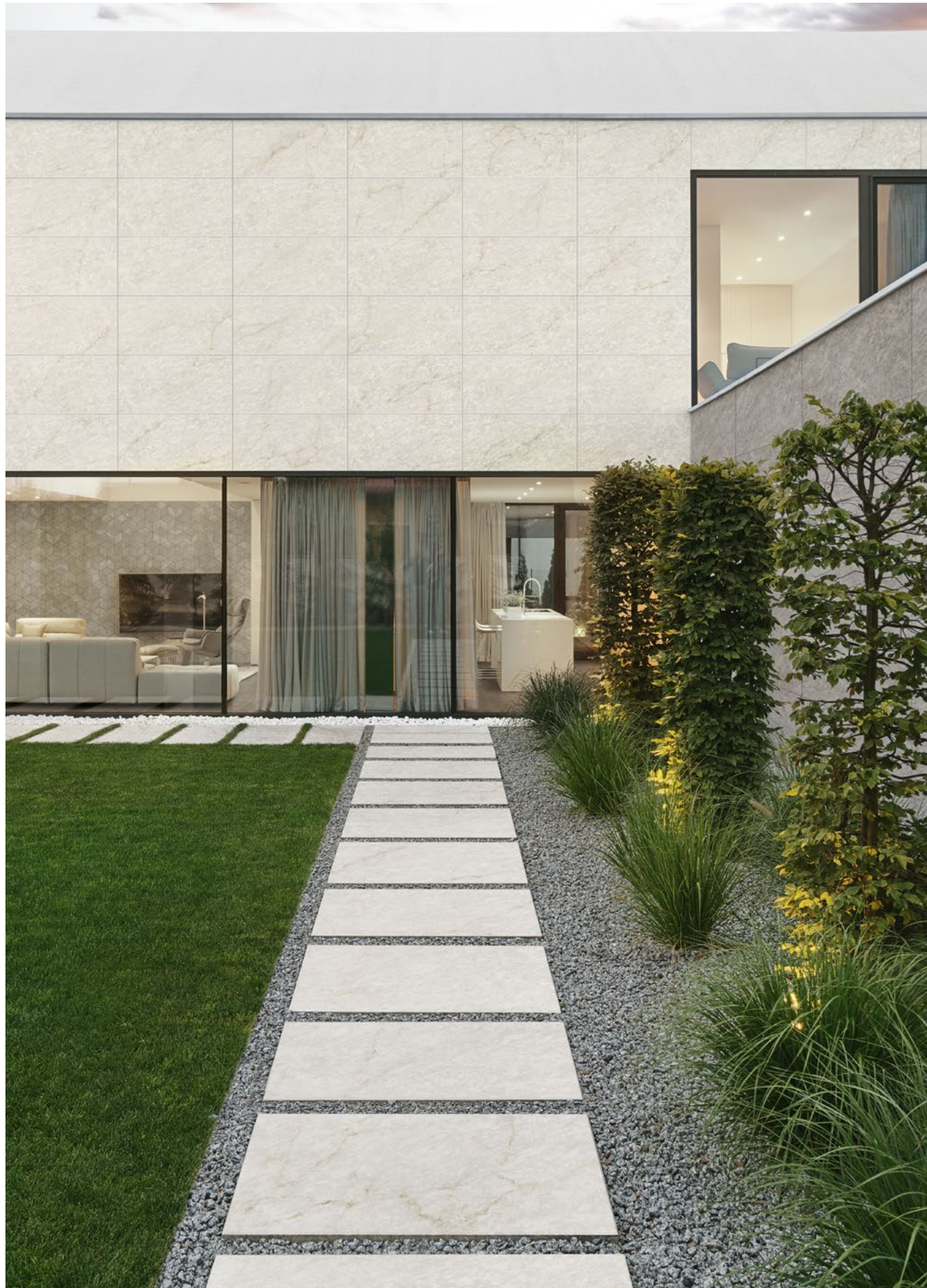

FLOOR

Outdoor Sensitech
Marvel X Fior di Bosco Hammered
 60x120 cm | 23⁵/₈"x47¹/₄" ✂ 20 mm
Marvel X Calacatta Apuano Hammered
 60x120 cm | 23⁵/₈"x47¹/₄" ✂ 20 mm

WALL

Marvel X Fior di Bosco Hammered
 60x120 cm | 23⁵/₈"x47¹/₄"
Marvel X Calacatta Apuano Hammered
 60x120 cm | 23⁵/₈"x47¹/₄"

INDEX



SIZE INDEX



SURFACE RANGE



IMAGE GALLERY



- STONE LOOK
- CONCRETE LOOK
- WOOD LOOK
- MARBLE LOOK

PRODUCT RANGE



TECHNICAL SPECIFICATIONS





Product Range

Stone Look

- ↔ BOOST ICOR
- ↔ BOOST MINERAL
- ↔ BOOST MIX
- ↔ BOOST STONE
- ↔ BRAVE
- ↔ LIMS
- ↔ NORDE
- ↔ NYRA

Concrete Look

- ↔ BOOST
- ↔ BOOST PRO
- ↔ BOOST BALANCE
- ↔ BOOST EXPRESSION
- ↔ BOOST NATURAL
- ↔ BOOST NATURAL PRO
- ↔ BOOST VISION

Wood Look

- ↔ LOG
- ↔ LOG CANSEI
- ↔ LOG SELECT
- ↔ ENTICE
- ↔ ETIC PRO
- ↔ EXENCE

Marble Look

- ↔ MARVEL MERAVIGLIA
- ↔ MARVEL X
- ↔ MARVEL T
- ↔ MARVEL TRAVERTINE

INDEX



SIZE INDEX



SURFACE RANGE



IMAGE GALLERY



PRODUCT RANGE



STONE LOOK
 CONCRETE LOOK
 WOOD LOOK
 MARBLE LOOK

TECHNICAL SPECIFICATIONS



Boost Icor

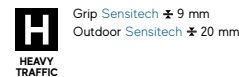

Grip Sensitech ± 9 mm
Outdoor Sensitech ± 20 mm



R11 C Grip Sensitech ± 9 mm
R11 C Outdoor Sensitech ± 20 mm



V3 Moderate Variation

OUTDOOR ± 20 mm Sensitech

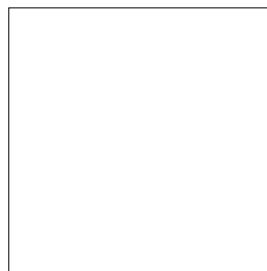

± 20 mm
120x120 cm - 47¹/₄"x47¹/₄"
AYCG Boost Icor Bone
AYCH Boost Icor Dust
AYCI Boost Icor Dune
AYCJ Boost Icor Oyster



± 20 mm
80x80 cm - 31¹/₂"x31¹/₂"
HBAX Boost Icor Bone
HBAY Boost Icor Dust
HBAZ Boost Icor Dune
HBA0 Boost Icor Oyster



± 20 mm
60x120 cm - 23⁵/₈"x47¹/₄"
AYCD Boost Icor Bone
AYCE Boost Icor Dust
AX8J Boost Icor Dune
AYCF Boost Icor Oyster

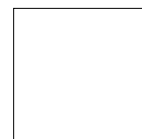

± 20 mm
60x60 cm - 23⁵/₈"x23⁵/₈"
AYCK Boost Icor Bone
AYCM Boost Icor Dust
AYCN Boost Icor Dune
AYCO Boost Icor Oyster

GRIP SURFACE Sensitech



± 9 mm
60x120 cm - 23⁵/₈"x47¹/₄"
AYA5 Boost Icor Bone
AYA6 Boost Icor Dust
AYA7 Boost Icor Dune
AYA8 Boost Icor Oyster
AYBQ Boost Icor Bone Railway *



± 9 mm
30x60 cm - 11³/₄"x23⁵/₈"
AYBL Boost Icor Bone
AYBM Boost Icor Dust
AYBN Boost Icor Dune
AYBO Boost Icor Oyster

*Graphic decor. Misalignments in the continuity between different patterns is normal for this type of product.
Decoro grafico. Eventuali disallineamenti nella continuità tra grafiche diverse sono una caratteristica intrinseca di questa tipologia di prodotto.

DECORS Sensitech



± 20 mm
Pebble A+B
59,5x59,5 cm - 23³/₈"x23³/₈"
AYZ1 Boost Icor Bone Pebble A+B
AYZ2 Boost Icor Dust Pebble A+B
AYZ3 Boost Icor Dune Pebble A+B
AYZ4 Boost Icor Oyster Pebble A+B

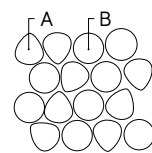

Pebble A: 0,259 mq
Pebble B: 0,252 mq

± 9 mm
Pebble A+B
59,5x59,5 cm - 23³/₈"x23³/₈"
AYZU Boost Icor Bone Pebble A+B
AYZV Boost Icor Dust Pebble A+B
AYZW Boost Icor Dune Pebble A+B
AYZX Boost Icor Oyster Pebble A+B

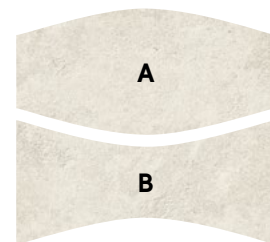

± 20 mm
Combo A
48,4x119 cm - 19¹/₈"x46⁷/₈"
AYZM Boost Icor Bone Combo A
AYZN Boost Icor Dust Combo A
AYZO Boost Icor Dune Combo A
AYZP Boost Icor Oyster Combo A

± 20 mm
Combo B
42,5x119 cm - 16³/₄"x46⁷/₈"
AYZQ Boost Icor Bone Combo B
AYZR Boost Icor Dust Combo B
AYZS Boost Icor Dune Combo B
AYZT Boost Icor Oyster Combo B

COLLECTION CATALOG

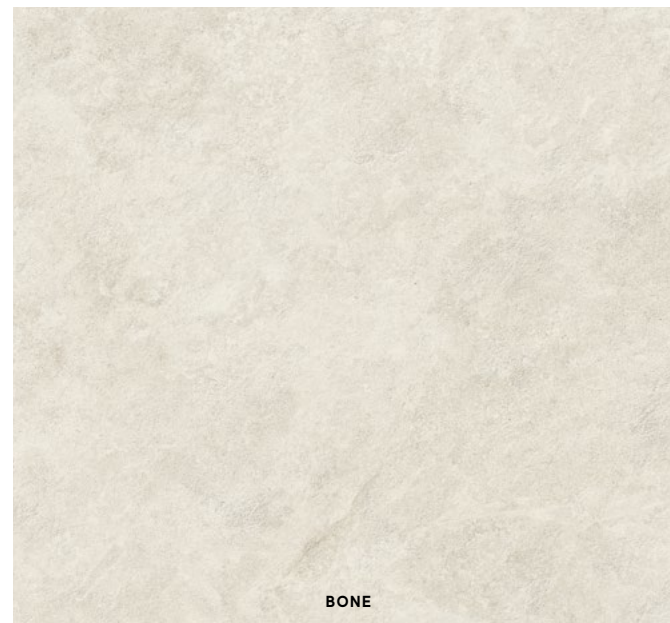

BONE

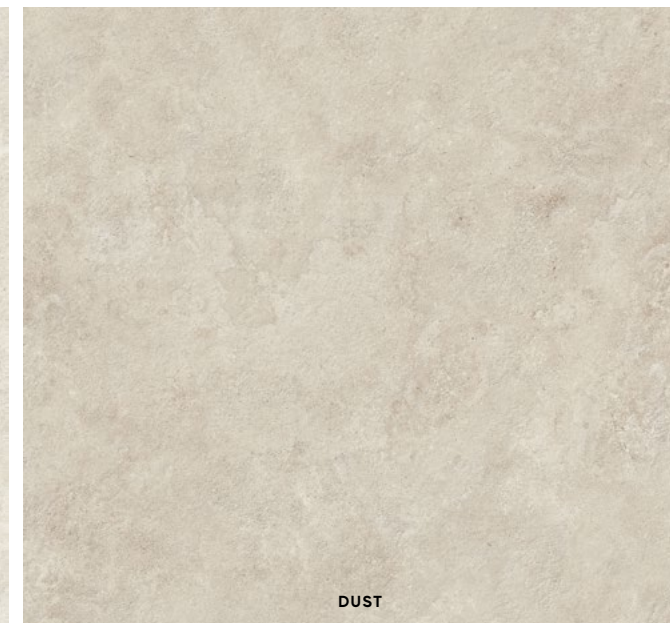

DUST

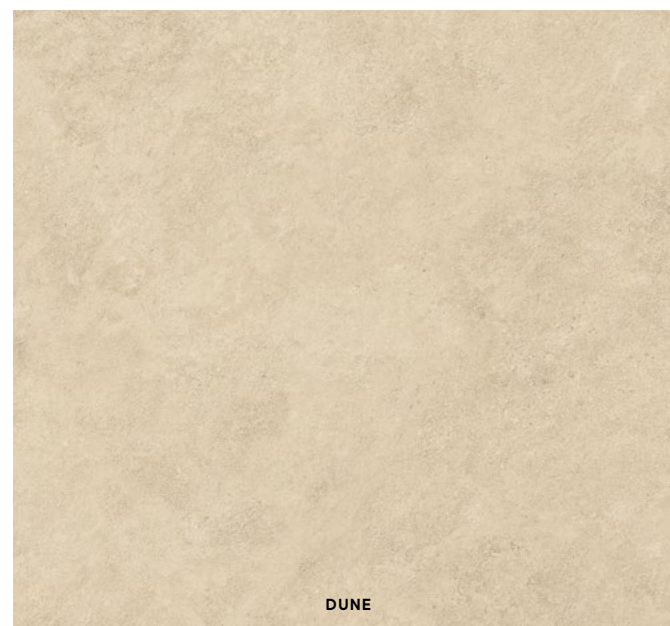

DUNE

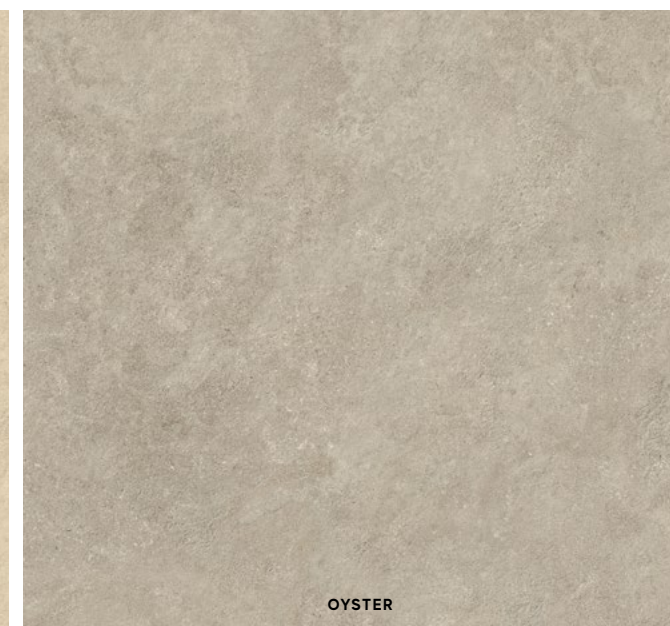

OYSTER



*BONE RAILWAY

INDEX



SIZE INDEX



SURFACE RANGE



IMAGE GALLERY



PRODUCT RANGE

STONE LOOK

CONCRETE LOOK

WOOD LOOK

MARBLE LOOK

TECHNICAL SPECIFICATIONS



Boost Mineral

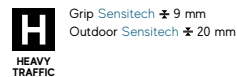

Grip Sensitech ± 9 mm
Outdoor Sensitech ± 20 mm



R11 C Grip Sensitech ± 9 mm
R11 C Outdoor Sensitech ± 20 mm



V3 Moderate Variation

OUTDOOR ± 20 mm Sensitech



± 20 mm
120x120 cm - 47¹/₈"x47¹/₈"
AH37 Boost Mineral Smoke
AH38 Boost Mineral Tarmac
AH35 Boost Mineral White
AH36 Boost Mineral Grey



± 20 mm
60x120 cm - 23⁵/₈"x47¹/₈"
AH4B Boost Mineral Smoke
AH4C Boost Mineral Tarmac
AH39 Boost Mineral White
AH4A Boost Mineral Grey



± 20 mm
60x90 cm - 23⁵/₈"x35³/₈"
AH4F Boost Mineral Smoke
AH4G Boost Mineral Tarmac
AH4D Boost Mineral White
AH4E Boost Mineral Grey



± 20 mm
60x60 cm - 23⁵/₈"x23⁵/₈"
AH4J Boost Mineral Smoke
AH4K Boost Mineral Tarmac
AH4H Boost Mineral White
AH4I Boost Mineral Grey

GRIP SURFACE Sensitech

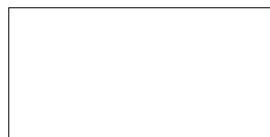

± 9 mm
60x120 cm - 23⁵/₈"x47¹/₈"
AHXJ Boost Mineral Smoke
AHXK Boost Mineral Tarmac
AHXG Boost Mineral White
AHXH Boost Mineral Pearl
AHXI Boost Mineral Grey



± 9 mm
60x60 cm - 23⁵/₈"x23⁵/₈"
AHXO Boost Mineral Smoke
AHXP Boost Mineral Tarmac
AHXL Boost Mineral White
AHXM Boost Mineral Pearl
AHXN Boost Mineral Grey

DECORS

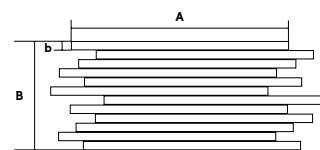

± 9 mm
Brick
30x60 cm - 11³/₄"x23⁵/₈"
AIGY Boost Mineral White
AIGZ Boost Mineral Pearl
AIG0 Boost Mineral Grey
AIG2 Boost Mineral Smoke
AIG3 Boost Mineral Tarmac

A: 59,5 cm - 18¹/₄"
B: 29,65 cm - 12⁵/₈"
b: 2,3 cm - 7¹/₂"

COLLECTION CATALOG



WHITE



PEARL

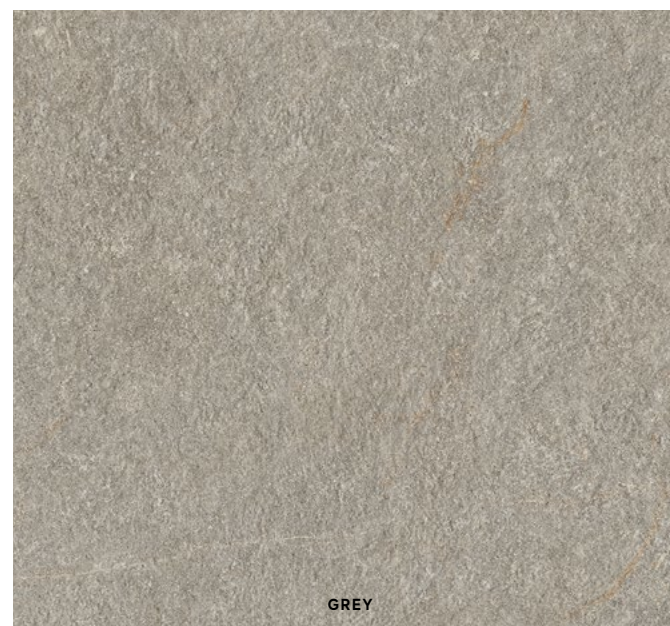

GREY

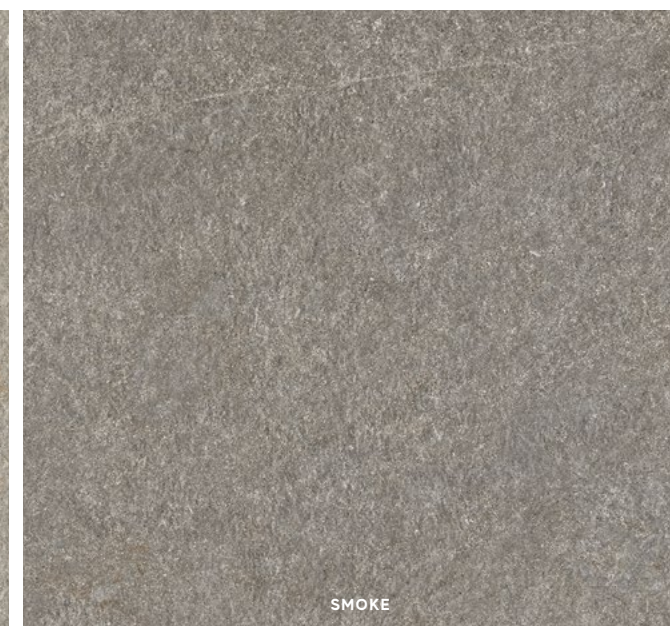

SMOKE



TARMAC

INDEX



SIZE INDEX



SURFACE RANGE



IMAGE GALLERY



PRODUCT RANGE

STONE LOOK

CONCRETE LOOK

WOOD LOOK

MARBLE LOOK

TECHNICAL SPECIFICATIONS



Boost Mix



Grip Sensitech ± 9 mm
Outdoor Sensitech ± 20 mm



R11 C Grip Sensitech ± 9 mm
R11 C Outdoor Sensitech ± 20 mm



V3 Moderate Variation

OUTDOOR ± 20 mm Sensitech

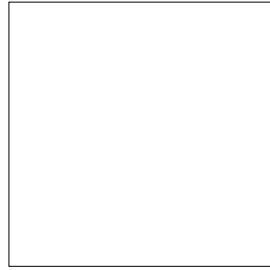

± 20 mm
120x120 cm - 47¹/₄"x47¹/₄"
A84U Boost Mix Ivory
A84V Boost Mix Pearl
A84W Boost Mix Smoke



± 20 mm
60x120 cm - 23⁵/₈"x47¹/₄"
A84R Boost Mix Ivory
A84S Boost Mix Pearl
A84T Boost Mix Smoke

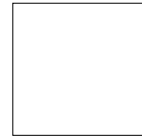

± 20 mm
60x60 cm - 23⁵/₈"x23⁵/₈"
A84O Boost Mix Ivory
A84P Boost Mix Pearl
A84Q Boost Mix Smoke

GRIP SURFACE Sensitech



± 9 mm
30x60 cm - 11³/₄"x23⁵/₈"
A8ØR Boost Mix Ivory
A8ØS Boost Mix Pearl
A8ØT Boost Mix Smoke

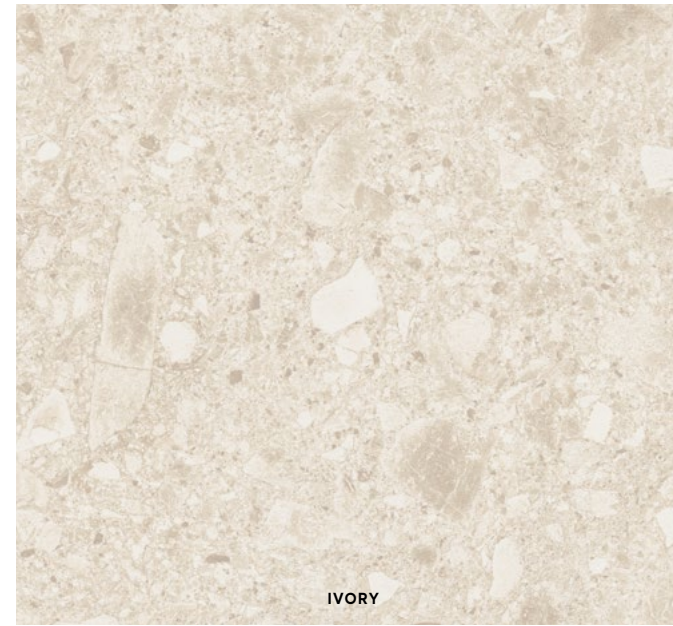

IVORY

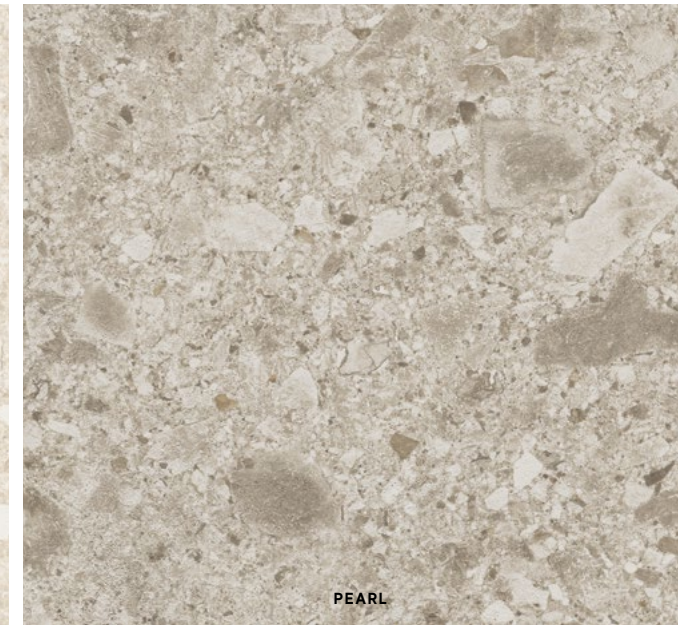

PEARL

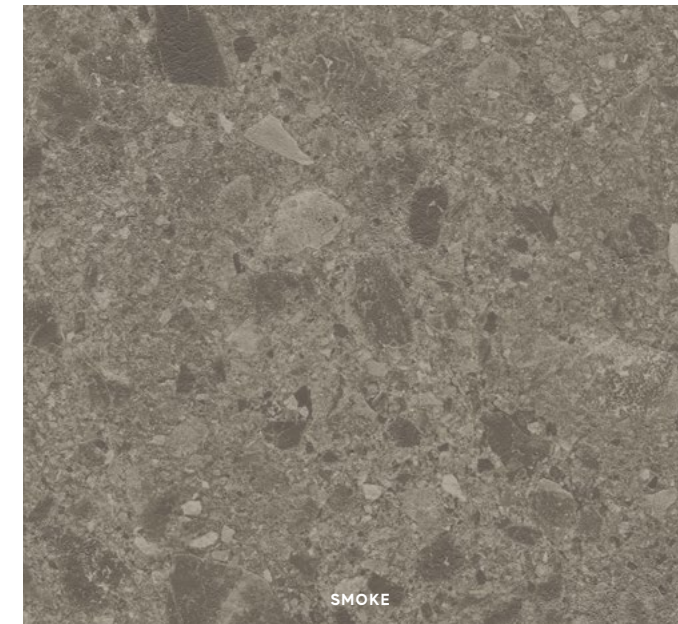

SMOKE

INDEX



SIZE INDEX



SURFACE RANGE



IMAGE GALLERY



PRODUCT RANGE



STONE LOOK

CONCRETE LOOK

WOOD LOOK

MARBLE LOOK

TECHNICAL SPECIFICATIONS



COLLECTION CATALOG



Boost Stone



OUTDOOR ± 20 mm Sensitech

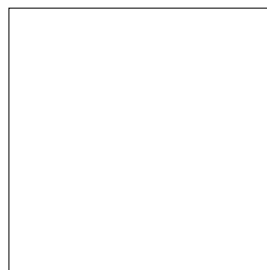

± 20 mm
120x120 cm - 47¹/₄"x47¹/₄"
 A67M Boost Stone White
 A67N Boost Stone Cream
 A67O Boost Stone Clay
 A67P Boost Stone Grey
 A7I Boost Stone Smoke
 A67Q Boost Stone Tarmac



± 20 mm
60x120 cm - 23⁵/₈"x47¹/₄"
 A67R Boost Stone White
 A67S Boost Stone Cream
 A67T Boost Stone Clay
 A67U Boost Stone Grey
 A7IJ Boost Stone Smoke
 A67V Boost Stone Tarmac



± 20 mm
60x60 cm - 23⁵/₈"x23⁵/₈"
 A67W Boost Stone White
 A67X Boost Stone Cream
 A67Y Boost Stone Clay
 A67Z Boost Stone Grey
 A7IK Boost Stone Smoke
 A67Ø Boost Stone Tarmac

GRIP SURFACE Sensitech



± 9 mm
60x120 cm - 23⁵/₈"x47¹/₄"
 A66R Boost Stone White
 A66S Boost Stone Ivory
 A66T Boost Stone Cream
 A66U Boost Stone Clay
 A66V Boost Stone Taupe
 A66Z Boost Stone Tobacco
 A66W Boost Stone Pearl
 A66X Boost Stone Grey
 A66Y Boost Stone Smoke
 A66Ø Boost Stone Tarmac

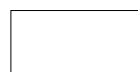

± 9 mm
30x60 cm - 11³/₄"x23⁵/₈"
 A661 Boost Stone White
 A662 Boost Stone Ivory
 A663 Boost Stone Cream
 A664 Boost Stone Clay
 A665 Boost Stone Taupe
 A669 Boost Stone Tobacco
 A666 Boost Stone Pearl
 A667 Boost Stone Grey
 A668 Boost Stone Smoke
 A67A Boost Stone Tarmac

DECORS



Boost Stone Pearl
Mosaico Brick 30x60 cm - 11³/₄"x23⁵/₈"
 A7C3 Boost Stone White
 A7C4 Boost Stone Ivory
 A7C5 Boost Stone Cream
 A7C6 Boost Stone Clay
 A7C7 Boost Stone Taupe
 A7DB Boost Stone Tobacco
 A7C8 Boost Stone Pearl
 A7C9 Boost Stone Grey
 A7DA Boost Stone Smoke
 A7DC Boost Stone Tarmac



A: 3,9x60 cm - 1¹/₂"x23⁵/₈"
 B: 1,7x60 cm - 5⁵/₈"x23⁵/₈"
 C: 4,6x60 cm - 1³/₄"x23⁵/₈"

COLLECTION CATALOG



INDEX



SIZE INDEX



SURFACE RANGE



IMAGE GALLERY



PRODUCT RANGE



STONE LOOK

CONCRETE LOOK

WOOD LOOK

MARBLE LOOK

TECHNICAL SPECIFICATIONS



Brave

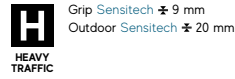

Grip **Sensitech** ± 9 mm
Outdoor **Sensitech** ± 20 mm



R11 C Grip **Sensitech** ± 9 mm
R11 C Outdoor **Sensitech** ± 20 mm



V2 Slight Variation

OUTDOOR ± 20 mm **Sensitech**



± 20 mm
60x120 cm - 23⁵/₈"x47¹/₄"
AT5I Brave Gypsum
AT5J Brave Pearl
AT5K Brave Grey
AT5M Brave Coke



± 20 mm
60x60 cm - 23⁵/₈"x23⁵/₈"
AXAT Brave Gypsum
AXAU Brave Pearl
AXAV Brave Grey
AXAX Brave Coke

GRIP SURFACE **Sensitech**



± 9 mm
30x60 cm - 11³/₄"x23⁵/₈"
DØ51 Brave Gypsum
DØ52 Brave Pearl
DØ53 Brave Grey
DØ55 Brave Coke

DECORS



Brave Listello 8x60 cm - 3¹/₈"x23⁵/₈"
A1X5 Brave Gypsum
A1X4 Brave Grey
A1X2 Brave Coke
A1X6 Brave Pearl



COLLECTION CATALOG



Lims

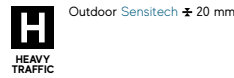

Outdoor **Sensitech** ± 20 mm



R11 C Outdoor **Sensitech** ± 20 mm



V3 Moderate Variation

OUTDOOR ± 20 mm **Sensitech**



± 20 mm
60x120 cm - 23⁵/₈"x47¹/₄"
A3LU Lims Ivory



± 20 mm
60x60 cm - 23⁵/₈"x23⁵/₈"
A3LY Lims Ivory

COLLECTION CATALOG



GYPSUM

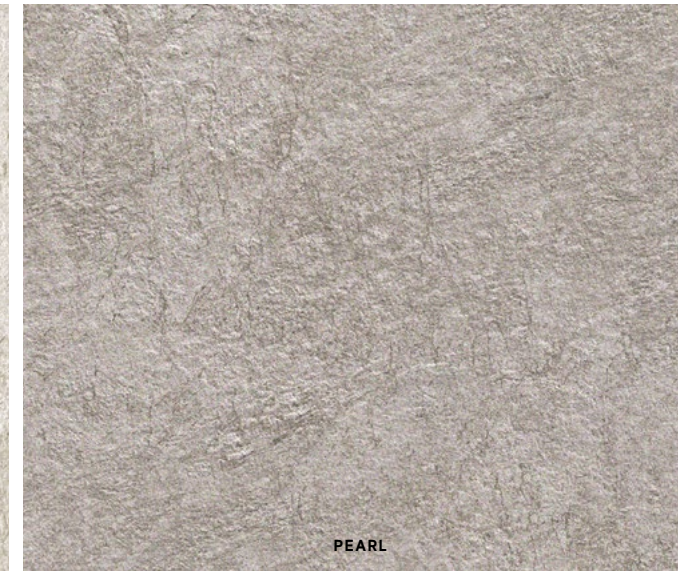

PEARL

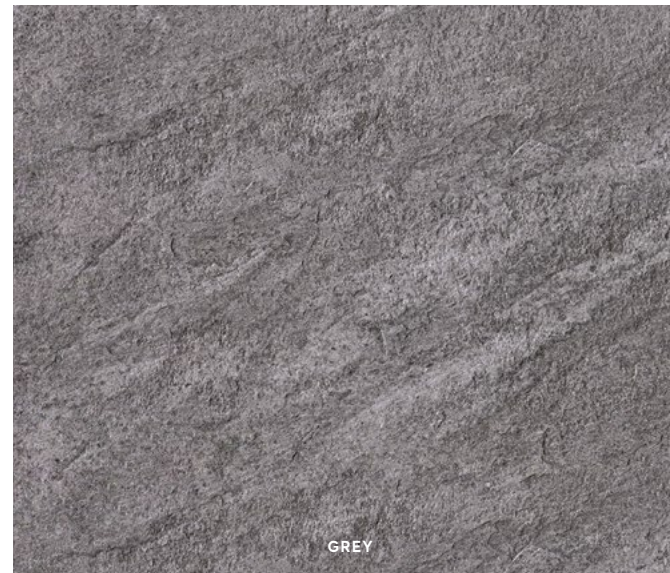

GREY

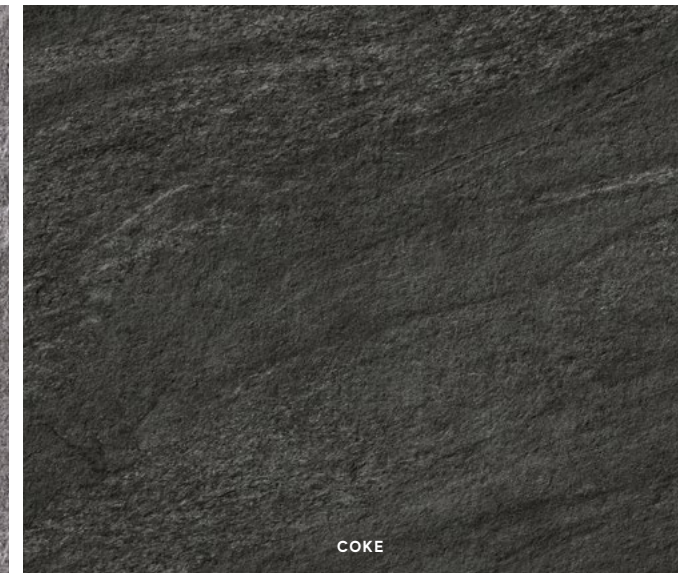

COKE

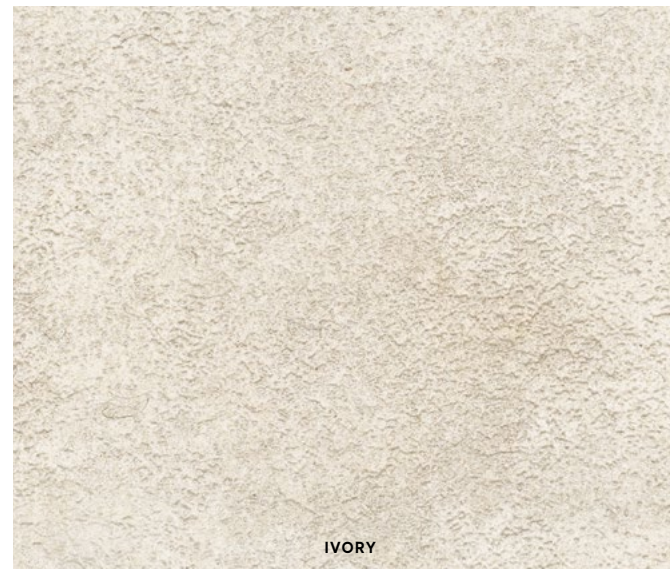

IVORY

INDEX



SIZE INDEX



SURFACE RANGE



IMAGE GALLERY



PRODUCT RANGE



STONE LOOK

CONCRETE LOOK

WOOD LOOK

MARBLE LOOK

TECHNICAL SPECIFICATIONS



Norde

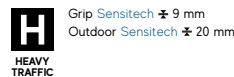

Grip Sensitech ± 9 mm
Outdoor Sensitech ± 20 mm



R11 C Grip Sensitech ± 9 mm
R11 C Outdoor Sensitech ± 20 mm



V3 Moderate
Variation

OUTDOOR ± 20 mm Sensitech



± 20 mm
60x120 cm - 23⁵/₈"x47¹/₄"
A5TV Norde Magnesio
A5TW Norde Oro
A451 Norde Platino
A5TX Norde Piombo



± 20 mm
60x90 cm - 23⁵/₈"x35³/₈"
A5T2 Norde Magnesio
A5T3 Norde Oro
A5T4 Norde Platino
A5T5 Norde Piombo



± 20 mm
80x80 cm - 31¹/₂"x31¹/₂"
A56L Norde Magnesio
A56M Norde Oro
A56N Norde Platino
A56O Norde Piombo



± 20 mm
60x60 cm - 23⁵/₈"x23⁵/₈"
A5TY Norde Magnesio
A5TZ Norde Oro
A5TØ Norde Platino
A5T1 Norde Piombo

GRIP SURFACE Sensitech



± 9 mm
60x120 cm - 23⁵/₈"x47¹/₄"
A5MH Norde Magnesio
A5MI Norde Oro
A45Ø Norde Platino
A5MJ Norde Piombo

Sensitech



± 20 mm
Norde Path A+B*
54x54 cm - 21¹/₄"x21¹/₄"
A58M Norde Magnesio
A58N Norde Oro
A58O Norde Platino
A58P Norde Piombo



± 20 mm
Norde Path C*
55x109 cm - 21⁵/₈"x42⁷/₈"
A58Q Norde Magnesio
A58R Norde Oro
A58S Norde Platino
A58T Norde Piombo



± 9 mm
Norde Composizione Palladiana Grip**
A58U Norde Magnesio
A58V Norde Oro
A58W Norde Platino
A58X Norde Piombo

** Example of layout measuring about 1 m². Minimum order: 8 m². Variable tessera size and shape with tumbled edge. We recommend installation with a joint of no less than 10 mm. Esempio di posato corrispondente a circa 1 mq. Ordine minimo di 8 mq. Dimensione e forma delle tessere variabile con bordo burattato. Si consiglia posa con fuga non inferiore a 10mm. Exemple de produit posé correspondant à 1 mètre carré environ. Commande minimum: 8 mètres carrés. Dimensions et forme des tesselles variables avec bord tamisé. Pose conseillée avec un joint non inférieur à 10mm. Verlegebeispiel für circa 1 qm. Mindestbestellmenge 8 qm. Abmessung und Form der Steine sind unterschiedlich, aber alle weisen getrommelte Kanten auf. Für die Verlegung wird eine Fugenbreite von nicht weniger als 10 mm empfohlen. Ejemplo de colocación correspondiente aproximadamente a 1 m. Pedido mínimo de 8 m. Tamaño y forma variable de los mosaicos con borde burinado. Se recomienda colocación con junta de no menos de 10 mm. Пример укладки, соответствующий примерно 1 кв.м. Минимальный объем заказа – 8 кв.м. Размер и форма чипс варьируются, чипсы имеют выщербленные края. Рекомендуется укладка с межплиточным швом не менее 10 мм.

* We recommend "dry" installation on gravel and/or grass. Si consiglia posa "a secco" su ghiaia e/o erba. Pose « à sec » sur gravillons et/ou herbe conseillée. Es wird eine Trockenverlegung auf Kies bzw. Rasen empfohlen. Se recomienda colocación «en seco» sobre grava o hierba. Рекомендуется «сухая» укладка на гравий и/или траву.

DECORS



Norde Brick
30x60 cm - 11³/₄"x23⁵/₈"
A59P Norde Magnesio
A59Q Norde Oro
A59R Norde Platino
A59S Norde Piombo

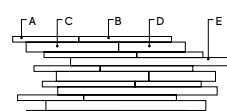

A: 2,1x24,8 cm - 3¹/₄"x9³/₄"
B: 2,1x34,5 cm - 3¹/₄"x13⁵/₈"
C: 3,3x34,5 cm - 1³/₄"x13⁵/₈"
D: 3,3x24,8 cm - 1³/₄"x9³/₄"
E: 2,5x60 cm - 1"x23⁵/₈"

COLLECTION CATALOG



MAGNESIO



ORO



PLATINO



PIOMBO

INDEX



SIZE INDEX



SURFACE RANGE



IMAGE GALLERY



PRODUCT RANGE

STONE LOOK

CONCRETE LOOK

WOOD LOOK

MARBLE LOOK

TECHNICAL SPECIFICATIONS



Nyra



OUTDOOR ± 20 mm Sensitech



± 20 mm
120x120 cm - 47¹/₄"x47¹/₄"
 HCSE Nyra Star
 HCSF Nyra Hay
 HCSG Nyra Sunlight
 HCOJ Nyra Mist



± 20 mm
60x120 cm - 23⁵/₈"x47¹/₄"
 HCSH Nyra Star
 HCSI Nyra Hay
 HCSJ Nyra Sunlight
 HCSK Nyra Mist
 HEWZ Nyra Ambrosia

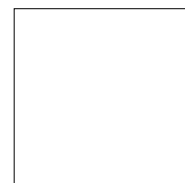

± 20 mm
80x80 cm - 31¹/₂"x31¹/₂"
 HCSP Nyra Star
 HCSQ Nyra Hay
 HCSR Nyra Sunlight
 HCSS Nyra Mist
 HEW0 Nyra Ambrosia

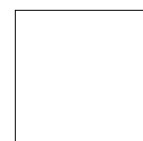

± 20 mm
60x60 cm - 23⁵/₈"x23⁵/₈"
 HCSL Nyra Star
 HCSM Nyra Hay
 HCSN Nyra Sunlight
 HCSO Nyra Mist

GRIP SURFACE Sensitech



± 9 mm
60x120 cm - 23⁵/₈"x47¹/₄"
 HCRB Nyra Star
 HCRC Nyra Hay
 HCRD Nyra Sunlight
 HCRE Nyra Mist
 HCRE Nyra Ambrosia

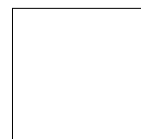

± 9 mm
60x60 cm - 23⁵/₈"x23⁵/₈"
 HCRL Nyra Hay
 HCRM Nyra Mist



± 9 mm
30x60 cm - 11³/₄"x23⁵/₈"
 HCRT Nyra Star
 HCRU Nyra Hay
 HCRV Nyra Sunlight
 HCRW Nyra Mist

DECORS Design by Alberto Apostoli

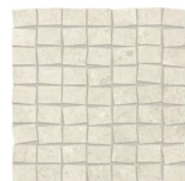

± 9 mm
Nyra Mosaico Opus Star
32x32 cm - 12⁵/₈"x12⁵/₈"
 HCU5 Nyra Star Opus
 HCU7 Nyra Hay Opus
 HCU8 Nyra Sunlight Opus
 HCU9 Nyra Mist Opus
 HCVA Nyra Meteor Opus
 HCVB Nyra Charcoal Opus
 HCVC Nyra Ambrosia Opus

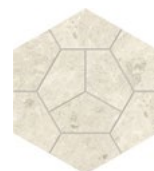

± 9 mm
Nyra Mosaico Favus Star
30x26 cm - 11³/₄"x10¹/₄"
 HCYK Nyra Star Favus
 HCYL Nyra Hay Favus
 HCYM Nyra Sunlight Favus
 HCVN Nyra Mist Favus
 HCYO Nyra Meteor Favus
 HCYP Nyra Charcoal Favus
 HCYQ Nyra Ambrosia Favus

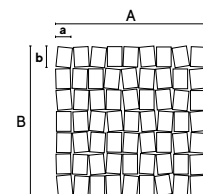

A: 31,9 cm - 14³/₅"
 B: 31,9 cm - 14³/₅"
 a: 3,2 cm - 1¹/₄"
 b: 4,3 cm - 7²/₅"

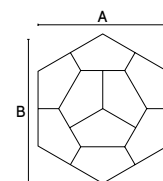

A: 30 cm - 11³/₄"
 B: 26 cm - 10¹/₄"

COLLECTION CATALOG



STAR

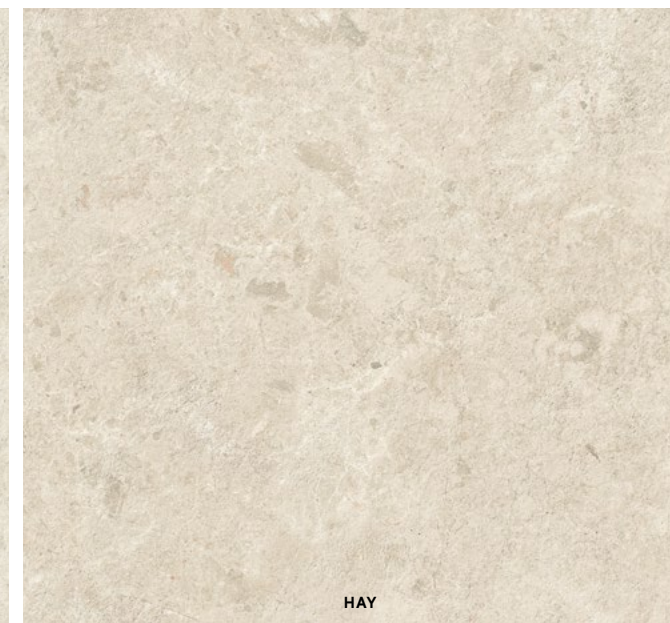

HAY

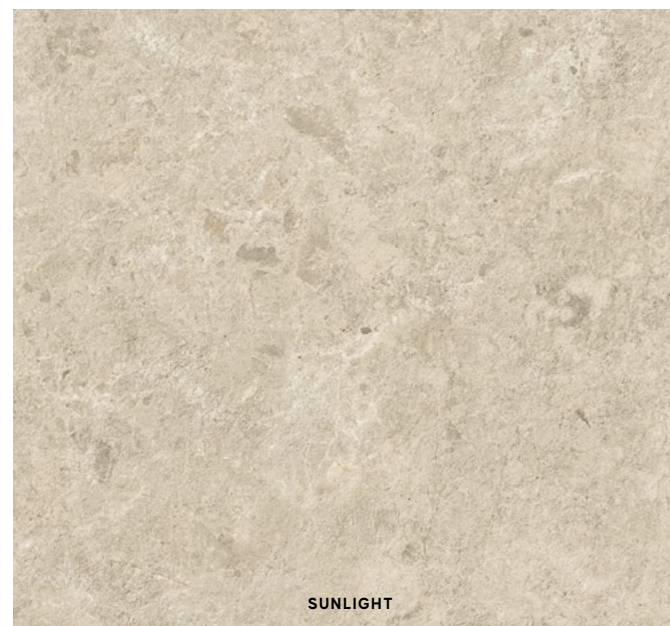

SUNLIGHT

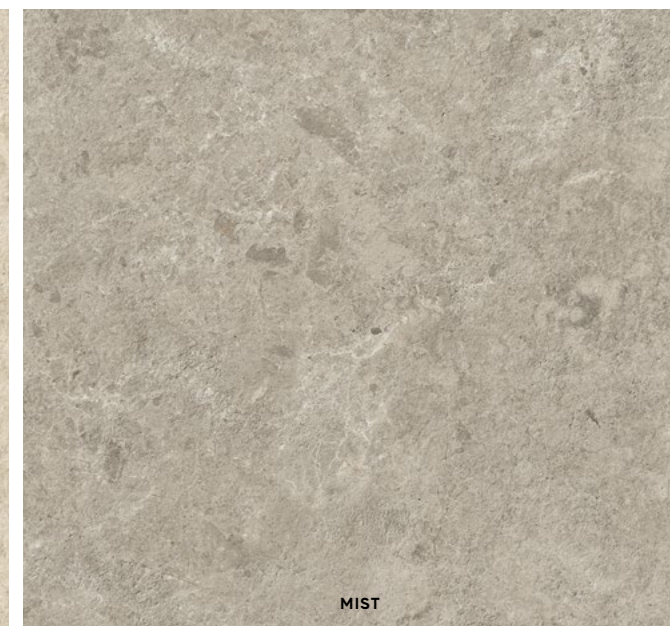

MIST



AMBROSIA

INDEX



SIZE INDEX



SURFACE RANGE



IMAGE GALLERY



PRODUCT RANGE

STONE LOOK

CONCRETE LOOK

WOOD LOOK

MARBLE LOOK

TECHNICAL SPECIFICATIONS



Boost Boost Pro



Grip Sensitech ± 9 mm
Outdoor Sensitech ± 20 mm



R11 C Grip Sensitech ± 9 mm
R11 C Outdoor Sensitech ± 20 mm



V3 Moderate Variation

OUTDOOR ± 20 mm Sensitech

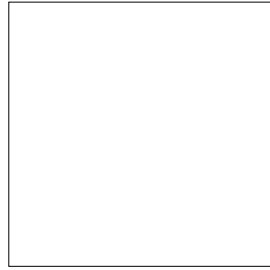

± 20 mm
120x120 cm - 47¹/₄" x 47¹/₄"
AMG3 Boost White
AMG5 Boost Grey
AMG6 Boost Smoke
AMG7 Boost Tarmac

A3DD Boost Pro Cream
A3DE Boost Pro Clay
A3DF Boost Pro Taupe
A3DH Boost Pro Tobacco



± 20 mm
60x120 cm - 23⁵/₈" x 47¹/₄"
AL8Ø Boost White
AL81 Boost Grey
AL82 Boost Smoke
AL83 Boost Tarmac

A4XU Boost Pro Cream
A4XV Boost Pro Clay
A4XW Boost Pro Taupe
A4XX Boost Pro Tobacco

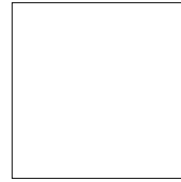

± 20 mm
80x80 cm - 31¹/₂" x 31¹/₂"
HANB Boost White
HANC Boost Grey
HAND Boost Smoke
HANE Boost Tarmac

HAN6 Boost Pro Cream
HAN7 Boost Pro Clay
HAN8 Boost Pro Taupe
HAOA Boost Pro Tobacco

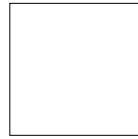

± 20 mm
60x60 cm - 23⁵/₈" x 23⁵/₈"
A3TJ Boost White
A3TK Boost Grey
A3TL Boost Smoke
A3TM Boost Tarmac

A4XQ Boost Pro Cream
A4XR Boost Pro Clay
A4XS Boost Pro Taupe
A4XT Boost Pro Tobacco

GRIP SURFACE Sensitech

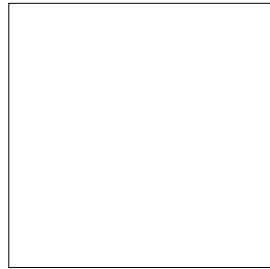

± 9 mm
120x120 cm - 47¹/₄" x 47¹/₄"
AMGN Boost White
AMGO Boost Pearl
AMGP Boost Grey
AMGQ Boost Smoke
AMGR Boost Tarmac

AØAO Boost Pro Ivory
AØAQ Boost Pro Cream
AØBV Boost Pro Clay
AØBW Boost Pro Taupe
AØBX Boost Pro Tobacco

COLLECTION CATALOG



BOOST

COLLECTION CATALOG



BOOST PRO



INDEX



SIZE INDEX



SURFACE RANGE



IMAGE GALLERY



PRODUCT RANGE



STONE LOOK

CONCRETE LOOK

WOOD LOOK

MARBLE LOOK

TECHNICAL SPECIFICATIONS



Boost Balance

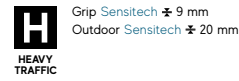

OUTDOOR ± 20 mm Sensitech

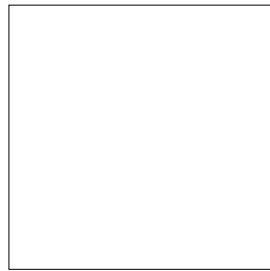

± 20 mm
120x120 cm - 47¹/₄"x47¹/₄"
 AJPE Boost Balance White
 AJPF Boost Balance Ash
 AJMH Boost Balance Pearl
 AJPG Boost Balance Grey

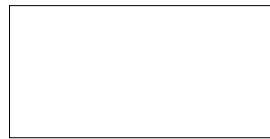

± 20 mm
60x120 cm - 23⁵/₈"x47¹/₄"
 AJPH Boost Balance White
 AJPI Boost Balance Ash
 AJPJ Boost Balance Pearl
 AJPK Boost Balance Grey



± 20 mm
60x60 cm - 23⁵/₈"x23⁵/₈"
 AJPL Boost Balance White
 AJPM Boost Balance Ash
 AJPN Boost Balance Pearl
 AJPO Boost Balance Grey

GRIP SURFACE Sensitech

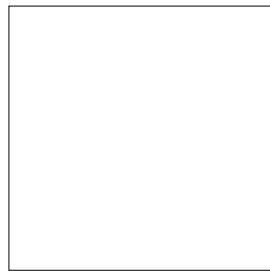

± 9 mm
120x120 cm - 47¹/₄"x47¹/₄"
 AJNC Boost Balance Pure
 AJND Boost Balance White
 AJNE Boost Balance Ivory
 AJNF Boost Balance Cream
 AJNG Boost Balance Ash
 AJNH Boost Balance Moon
 AJNI Boost Balance Pearl
 AJNJ Boost Balance Grey
 AJNK Boost Balance Smoke
 AJNL Boost Balance Tarmac

COLLECTION
 CATALOG



INDEX



SIZE INDEX



SURFACE
 RANGE



IMAGE GALLERY



PRODUCT RANGE

STONE LOOK

CONCRETE LOOK

WOOD LOOK

MARBLE LOOK

TECHNICAL
 SPECIFICATIONS



Boost Expression

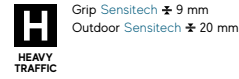

OUTDOOR ± 20 mm Sensitech

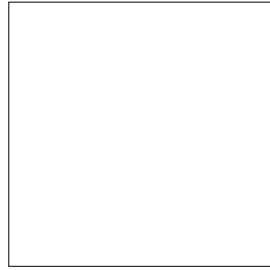

± 20 mm
120x120 cm - 47¹/₄"x47¹/₄"
 AYRT Boost Expression Haze
 AYRS Boost Expression Ice
 AYRU Boost Expression Shell

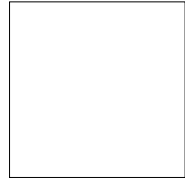

± 20 mm
80x80 cm - 31¹/₂"x31¹/₂"
 AYRZ Boost Expression Haze
 AYRY Boost Expression Ice
 AYRØ Boost Expression Shell



± 20 mm
60x120 cm - 23⁵/₈"x47¹/₄"
 AYRW Boost Expression Haze
 AYRV Boost Expression Ice
 AYRX Boost Expression Shell

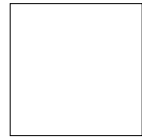

± 20 mm
60x60 cm - 23⁵/₈"x23⁵/₈"
 AYR2 Boost Expression Haze
 AYR1 Boost Expression Ice
 AYR3 Boost Expression Shell

GRIP SURFACE Sensitech

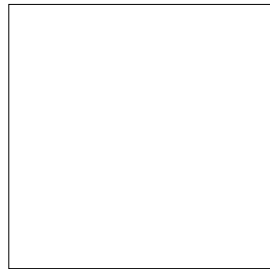

± 9 mm
120x120 cm - 47¹/₄"x47¹/₄"
 AYUO Boost Expression Haze
 AYUR Boost Expression Camel
 AYUS Boost Expression Tan
 AYUN Boost Expression Ice
 AYUQ Boost Expression Glow
 AYUP Boost Expression Shell



± 9 mm
60x120 cm - 23⁵/₈"x47¹/₄"
 AYU1 Boost Expression Haze
 AYU4 Boost Expression Camel
 AYU5 Boost Expression Tan
 AYUØ Boost Expression Ice
 AYU3 Boost Expression Glow
 AYU2 Boost Expression Shell

COLLECTION
 CATALOG

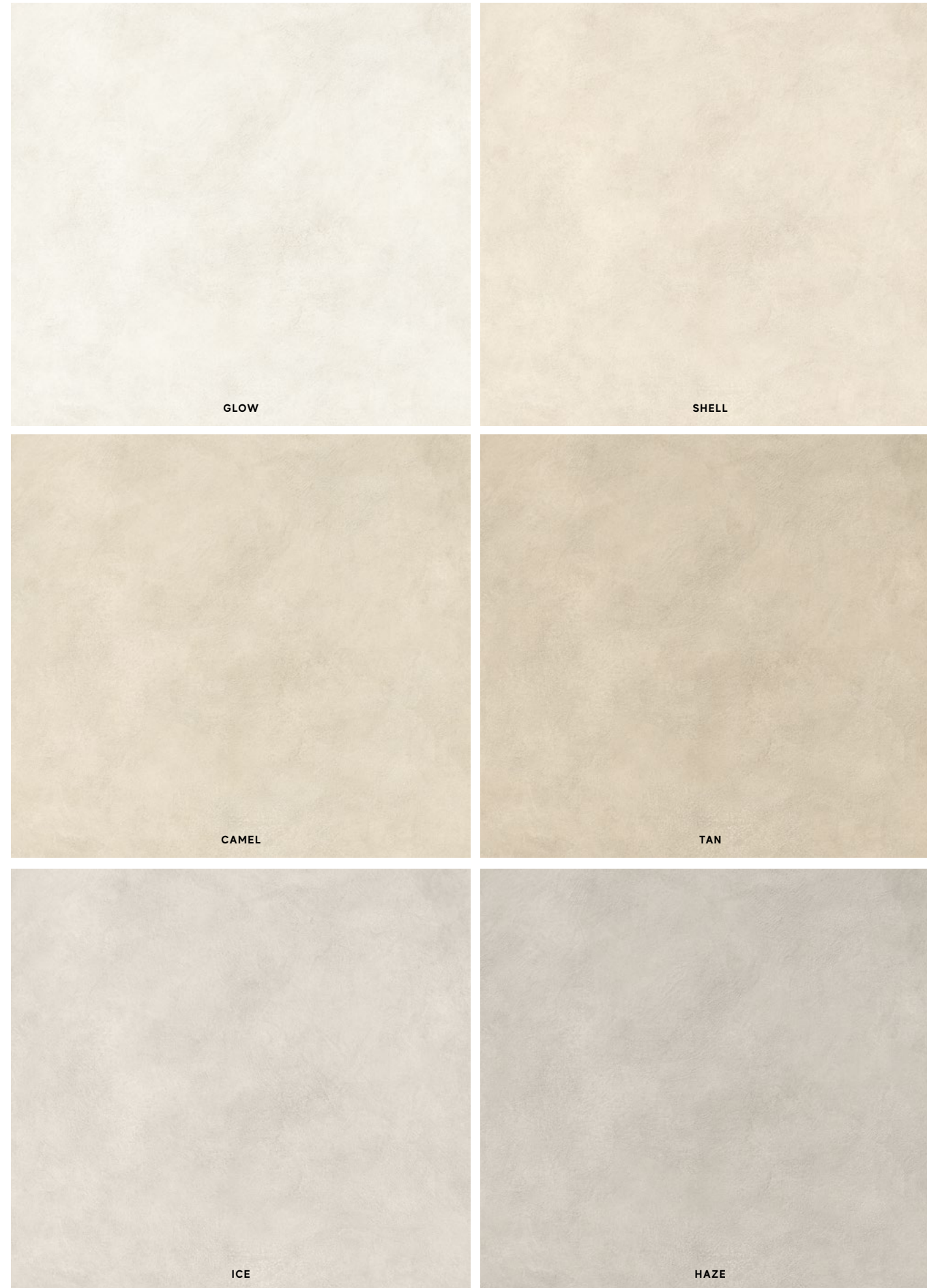

INDEX



SIZE INDEX



SURFACE
 RANGE



IMAGE GALLERY



PRODUCT RANGE

STONE LOOK

CONCRETE LOOK

WOOD LOOK

MARBLE LOOK

TECHNICAL
 SPECIFICATIONS



Boost Natural Boost Natural Pro



Grip Sensitech ± 9 mm
Outdoor Sensitech ± 20 mm



R11 C Grip Sensitech ± 9 mm
R11 C Outdoor Sensitech ± 20 mm



V2 Slight
Variation

OUTDOOR ± 20 mm Sensitech

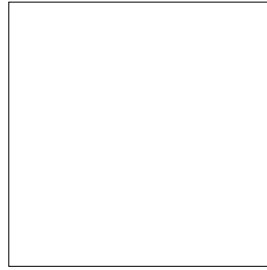

± 20 mm
120x120 cm - 47¹/₄"x47¹/₄"
A7Q9 Boost Natural Ecrú
A7Q7 Boost Natural Kaolin
A7Q8 Boost Natural Ash



± 20 mm
60x60 cm - 23⁵/₈"x23⁵/₈"
A7RC Boost Natural Ecrú
A7RA Boost Natural Kaolin
A7RB Boost Natural Ash



± 20 mm
60x120 cm - 23⁵/₈"x47¹/₄"
ARB6 Boost Natural Pro Oat
ARB7 Boost Natural Pro Cinder

ARB2 Boost Natural Pro Oat
ARB4 Boost Natural Pro Cinder

ARB8 Boost Natural Pro Oat
ARB9 Boost Natural Pro Cinder

GRIP SURFACE Sensitech

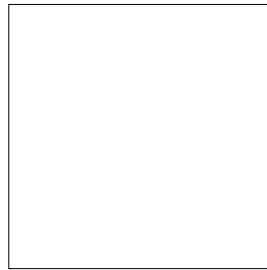

± 9 mm
120x120 cm - 47¹/₄"x47¹/₄"
A655 Boost Natural Ecrú
A656 Boost Natural Umber
A657 Boost Natural Coal
A653 Boost Natural Kaolin
A654 Boost Natural Ash

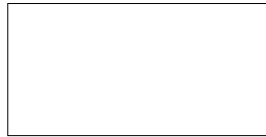

± 9 mm
60x120 cm - 23⁵/₈"x47¹/₄"
A65Ø Boost Natural Ecrú
A651 Boost Natural Umber
A652 Boost Natural Coal
A65Y Boost Natural Kaolin
A65Z Boost Natural Ash

AQ9J Boost Natural Pro Salt
AQ9K Boost Natural Pro Oat
AQ9L Boost Natural Pro Sand
AQ9M Boost Natural Pro Cinder
AQ9N Boost Natural Pro Dove

AQ9P Boost Natural Pro Salt
AQ9Q Boost Natural Pro Oat
AQ9R Boost Natural Pro Sand
AQ9S Boost Natural Pro Cinder
AQ9T Boost Natural Pro Dove

COLLECTION
CATALOG



BOOST
NATURAL

COLLECTION
CATALOG



BOOST
NATURAL PRO



INDEX



SIZE INDEX



SURFACE
RANGE



IMAGE GALLERY



PRODUCT RANGE

STONE LOOK

CONCRETE LOOK

WOOD LOOK

MARBLE LOOK

TECHNICAL
SPECIFICATIONS



Boost Vision

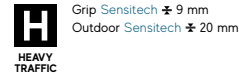

OUTDOOR ± 20 mm Sensitech

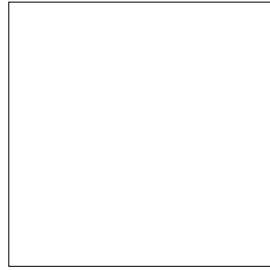

± 20 mm
120x120 cm - 47¹/₄"x47¹/₄"
 HCK0 Boost Vision Ash
 HCK1 Boost Vision Haze
 HCK2 Boost Vision Grey



± 20 mm
60x120 cm - 23⁵/₈"x47¹/₄"
 HCUU Boost Vision Ash
 HCUV Boost Vision Haze
 HCUW Boost Vision Grey

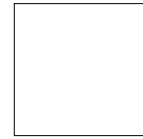

± 20 mm
60x60 cm - 23⁵/₈"x23⁵/₈"
 HCUX Boost Vision Ash
 HCUY Boost Vision Haze
 HCUZ Boost Vision Grey

GRIP SURFACE Sensitech

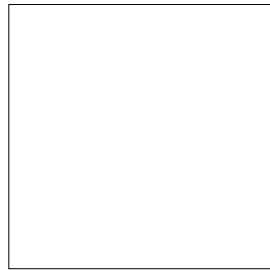

± 9 mm
120x120 cm - 47¹/₄"x47¹/₄"
 HCJN Boost Vision Glow
 HCJO Boost Vision Camel
 HCJP Boost Vision Ash
 HCJQ Boost Vision Haze
 HCJR Boost Vision Grey

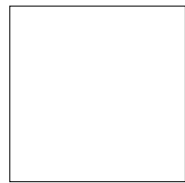

± 9 mm
80x80 cm - 31¹/₂"x31¹/₂"
 HCI4 Boost Vision Glow
 HCI5 Boost Vision Camel
 HCI7 Boost Vision Ash
 HCI8 Boost Vision Haze
 HCI9 Boost Vision Grey

DECORS - METAL LOOK



± 9 mm
Boost Vision Corten
 Matte Sensitech
60x120 cm - 23⁵/₈"x47¹/₄"
 HCJX Boost Vision Corten



± 9 mm
Boost Vision Brass
 Matte Sensitech
60x120 cm - 23⁵/₈"x47¹/₄"
 HCJY Boost Vision Brass



± 9 mm
Boost Vision Steel
 Matte Sensitech
60x120 cm - 23⁵/₈"x47¹/₄"
 HCJZ Boost Vision Steel

± 6 mm
120x278 cm - 47¹/₄"x109¹/₂"
 HCJF Boost Vision Corten

± 6 mm
120x278 cm - 47¹/₄"x109¹/₂"
 HCJG Boost Vision Brass

± 6 mm
120x278 cm - 47¹/₄"x109¹/₂"
 HCJH Boost Vision Steel

COLLECTION CATALOG



GLOW



CAMEL

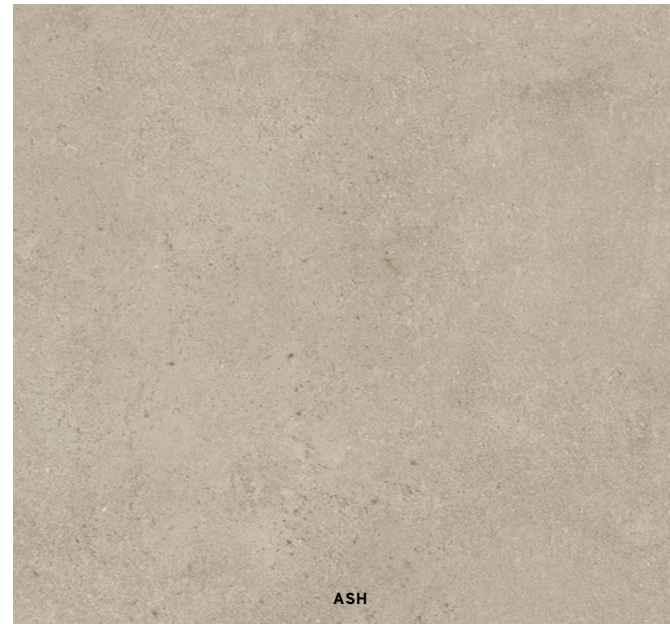

ASH

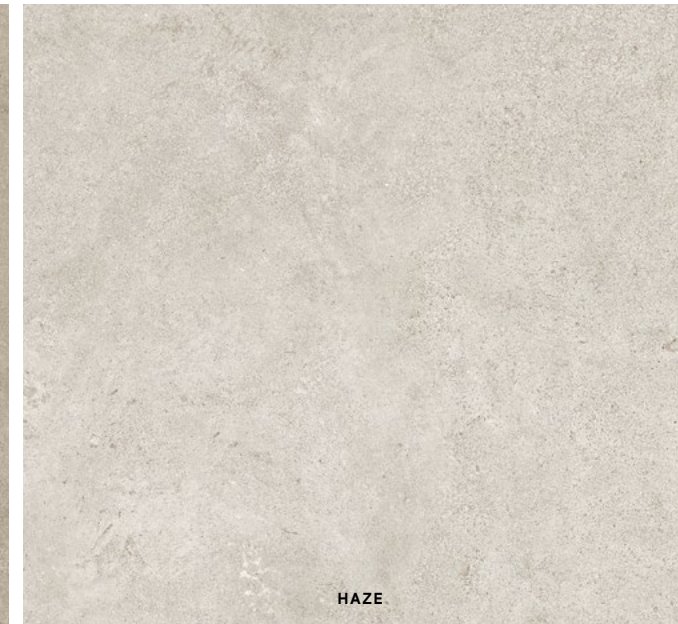

HAZE

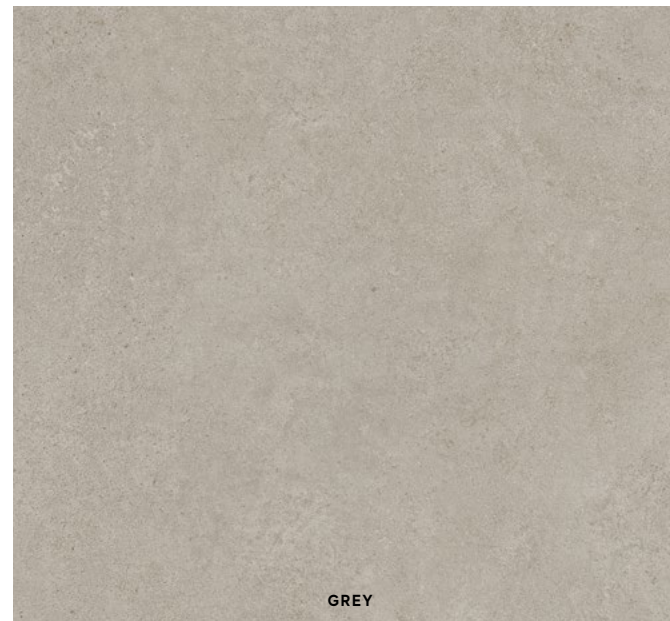

GREY

INDEX



SIZE INDEX



SURFACE RANGE



IMAGE GALLERY



PRODUCT RANGE

STONE LOOK

CONCRETE LOOK

WOOD LOOK

MARBLE LOOK

TECHNICAL SPECIFICATIONS



Log

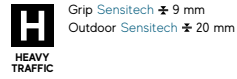

Grip Sensitech ± 9 mm
Outdoor Sensitech ± 20 mm



R11 C Grip Sensitech ± 9 mm
R11 C Outdoor Sensitech ± 20 mm



V3 Moderate
Variation

OUTDOOR ± 20 mm Sensitech



± 20 mm
30x120cm - 11³/₈"x47¹/₄"
AX4A Log Icon Oak Forest
AX4B Log Bright Oak Forest
AX4C Log Amber Oak Forest
AX4D Log Deep Oak Forest
AX4E Log Moon Oak Forest

GRIP SURFACE Sensitech



± 9 mm
20x120cm - 7⁷/₈"x47¹/₄"
AX4H Log Icon Oak Forest
AX4I Log Bright Oak Forest
AX4J Log Amber Oak Forest
AX4K Log Deep Oak Forest
AX4L Log Moon Oak Forest

OUTDOOR ± 20 mm Sensitech



± 20 mm
60x120 cm - 23⁵/₈"x47¹/₄"



AXØT Log Icon Oak Deck ▲



AXØU Log Bright Oak Deck ▲

▲Graphic pattern. Misalignments in the continuity between different patterns is normal for this type of product.
Decoro grafico. Eventuali disallineamenti nella continuità tra grafiche diverse sono una caratteristica intrinseca di questa tipologia di prodotto.

COLLECTION
CATALOG



ICON OAK FOREST



BRIGHT OAK FOREST



AMBER OAK FOREST



DEEP OAK FOREST



MOON OAK FOREST

INDEX



SIZE INDEX



SURFACE
RANGE



IMAGE GALLERY



PRODUCT RANGE



STONE LOOK
CONCRETE LOOK

WOOD LOOK
MARBLE LOOK

TECHNICAL
SPECIFICATIONS



Log Cansei



Grip Sensitech ± 9 mm



R11 C Grip Sensitech ± 9 mm



V3 Moderate Variation

GRIP SURFACE Sensitech



± 9 mm

20x120cm - 7 7/8" x 47 1/4"

AX7J Log Cansei Sospiro

AX7K Log Cansei Rialto

AX7L Log Cansei Fenice

AX7M Log Cansei Murano

AX7N Log Cansei Darsena

DECORS



Log Cansei Rigga Sospiro

Matte Sensitech

18,5x150 cm - 7 1/4" x 59"

AX9S Log Cansei Rigga Sospiro

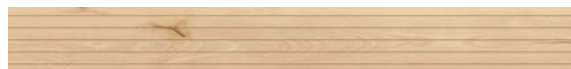

Log Cansei Rigga Rialto

Matte Sensitech

18,5x150 cm - 7 1/4" x 59"

AX9T Log Cansei Rigga Rialto



Log Cansei Rigga Murano

Matte Sensitech

18,5x150 cm - 7 1/4" x 59"

AX9U Log Cansei Rigga Murano

COLLECTION CATALOG



Graphic pattern. Misalignments in the continuity between different patterns is normal for this type of product.
Decoro grafico. Eventuali disallineamenti nella continuità tra grafiche diverse sono una caratteristica intrinseca di questa tipologia di prodotto.



SOSPIRO

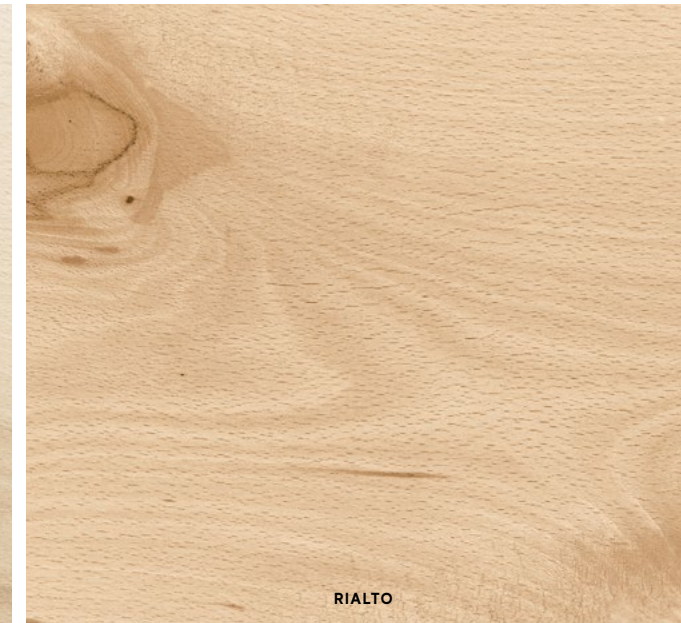

RIALTO

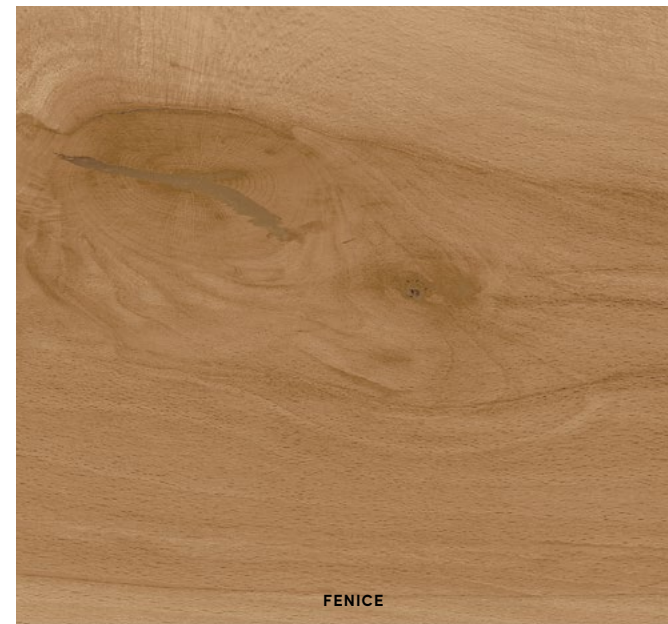

FENICE



MURANO

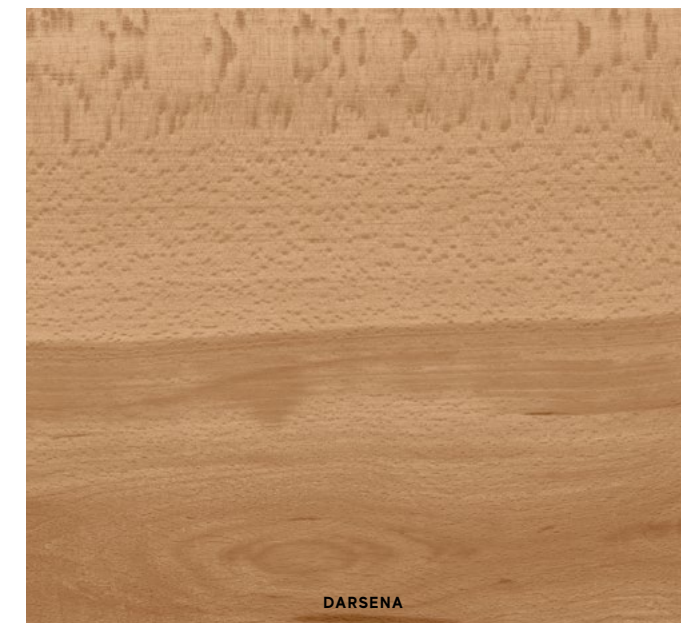

DARSENA

INDEX



SIZE INDEX



SURFACE RANGE



IMAGE GALLERY



PRODUCT RANGE



STONE LOOK

CONCRETE LOOK

WOOD LOOK

MARBLE LOOK

TECHNICAL SPECIFICATIONS



Log Select



Grip Sensitech ± 9 mm
Outdoor Sensitech ± 20 mm



R11 C Grip Sensitech ± 9 mm
R11 C Outdoor Sensitech ± 20 mm



V3 Moderate
Variation

OUTDOOR ± 20 mm Sensitech



± 20 mm
30x120cm - 11³/₄"x47¹/₄"
HCAD Log Select Icon Flamed
HCAH Log Select Silver Flamed

GRIP SURFACE Sensitech



± 9 mm
20x120cm - 7⁷/₈"x47¹/₄"
HCAY Log Select Bright Pure
HCAZ Log Select Icon Pure
HCAO Log Select Amber Pure
HCFJ Log Select Bright Flamed
HCFK Log Select Icon Flamed
HCFL Log Select Silver Flamed

COLLECTION
CATALOG



BRIGHT PURE



ICON PURE



AMBER PURE



BRIGHT FLAMED



ICON FLAMED



SILVER FLAMED

INDEX



SIZE INDEX



SURFACE
RANGE



IMAGE GALLERY



PRODUCT RANGE



STONE LOOK
CONCRETE LOOK

WOOD LOOK
MARBLE LOOK

TECHNICAL
SPECIFICATIONS



Entice

H HEAVY TRAFFIC | Grip Sensitech ± 9 mm | Outdoor Sensitech ± 20 mm | **R11 C** Grip Sensitech ± 9 mm | **R11 C** Outdoor Sensitech ± 20 mm | V2 Slight Variation

OUTDOOR ± 20 mm Sensitech



± 20 mm
30x120 cm - 11³/₄"x47¹/₄"
 A9DD Entice Pale Oak Natural
 A9DE Entice Copper Oak Natural
 A9DF Entice Browned Oak Natural
 A9DG Entice Ash Oak Natural

GRIP SURFACE Sensitech

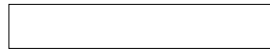

± 9 mm
20x120 cm - 7⁷/₈"x47¹/₄"
 A842 Entice Pale Oak Natural
 A843 Entice Copper Oak Natural
 A844 Entice Browned Oak Natural
 A845 Entice Ash Oak Natural

COLLECTION CATALOG



Etic Pro

H HEAVY TRAFFIC | Outdoor Sensitech ± 20 mm | **R11 C** Outdoor Sensitech ± 20 mm | V3 Moderate Variation

OUTDOOR ± 20 mm Sensitech

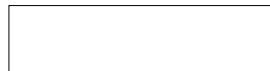

± 20 mm
30x120 cm - 11³/₄"x47¹/₄"
 AV42 Etic Pro Rovere Venice

COLLECTION CATALOG



PALE OAK NATURAL



COPPER OAK NATURAL



BROWNEO OAK NATURAL

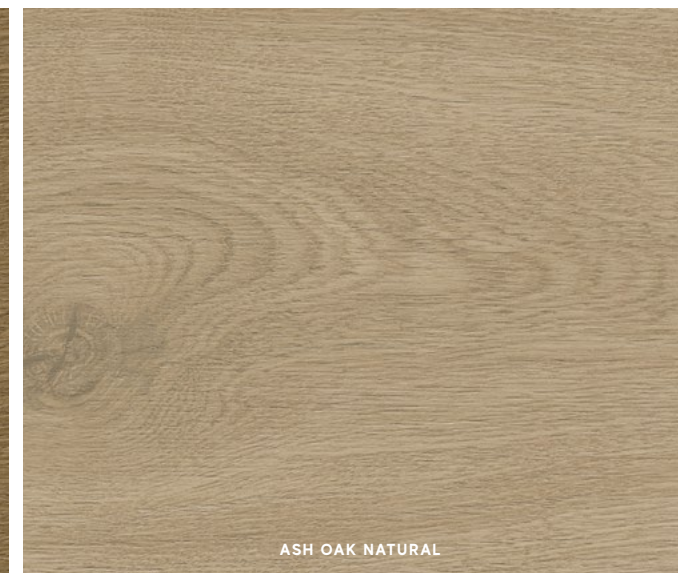

ASH OAK NATURAL

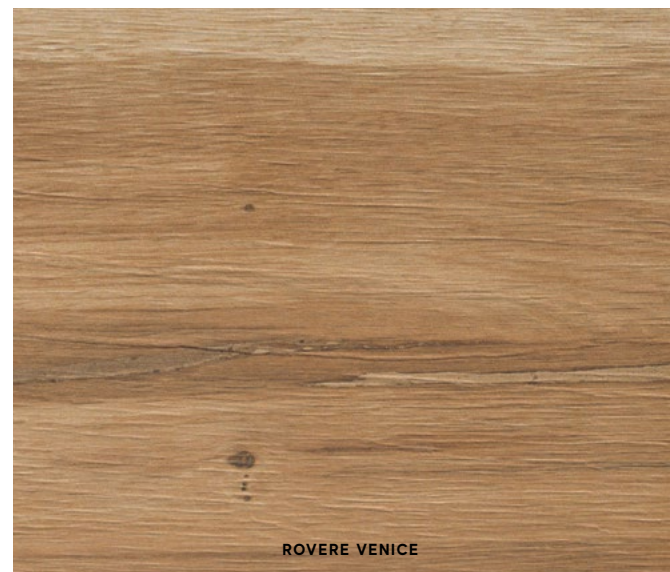

ROVERE VENICE

INDEX



SIZE INDEX



SURFACE RANGE



IMAGE GALLERY



PRODUCT RANGE



STONE LOOK
CONCRETE LOOK

WOOD LOOK
MARBLE LOOK

TECHNICAL SPECIFICATIONS



Exence

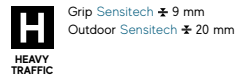

Grip Sensitech ± 9 mm
Outdoor Sensitech ± 20 mm



R11 C Grip Sensitech ± 9 mm
R11 C Outdoor Sensitech ± 20 mm



V3 Moderate Variation

OUTDOOR ± 20 mm Sensitech



± 20 mm
30x120cm - 11³/₄"x47¹/₄"
A2RY Exence Almond
A2RZ Exence Amber

GRIP SURFACE Sensitech



± 9 mm
18,5x150 cm - 7¹/₄"x59"
AOUK Exence Vanilla
AOUI Exence Almond
AOUJ Exence Amber



VANILLA



ALMOND

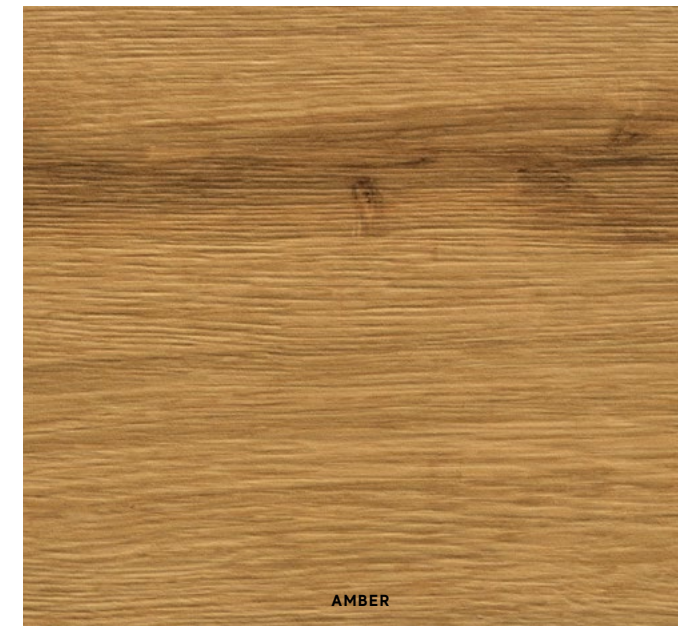

AMBER

DECORS



Exence Tatami 18,5x75 cm - 7¹/₄"x29¹/₂"
AOUR Exence Vanilla
AOUS Exence Almond
AOUT Exence Amber

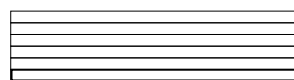

2,85x74,4 cm - 1¹/₈"x29³/₈"

COLLECTION CATALOG



INDEX



SIZE INDEX



SURFACE RANGE



IMAGE GALLERY



PRODUCT RANGE



STONE LOOK
CONCRETE LOOK

WOOD LOOK
MARBLE LOOK

TECHNICAL SPECIFICATIONS



Marvel Meraviglia

OUTDOOR ± 20 mm **Sensitech**



± 20 mm

60x120 cm - 23⁵/₈"x47¹/₄"

AJPQ Marvel Meraviglia Calacatta Meraviglia Hammered

AJPR Marvel Meraviglia Calacatta Bernini Hammered

AJPS Marvel Meraviglia Grigio Elegante Hammered

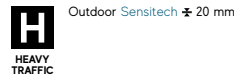

Outdoor **Sensitech** ± 20 mm



R11 C Outdoor **Sensitech** ± 20 mm



V3 Moderate Variation

COLLECTION CATALOG



Marvel X

OUTDOOR ± 20 mm **Sensitech**



± 20 mm

60x120 cm - 23⁵/₈"x47¹/₄"

AGFA Marvel X Calacatta Apuano Hammered

AGFB Marvel X Fior di Bosco Hammered



Outdoor **Sensitech** ± 20 mm



R11 C Outdoor **Sensitech** ± 20 mm



V3 Moderate Variation

COLLECTION CATALOG



CALACATTA MERAIGLIA



CALACATTA BERNINI



GRIGIO ELEGANTE



CALACATTA APUANO HAMMERED



FIOR DI BOSCO HAMMERED

INDEX



SIZE INDEX



SURFACE RANGE



IMAGE GALLERY



PRODUCT RANGE



- STONE LOOK
- CONCRETE LOOK
- WOOD LOOK
- MARBLE LOOK

TECHNICAL SPECIFICATIONS



Marvel T

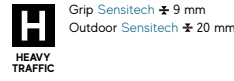

Grip Sensitech ± 9 mm
Outdoor Sensitech ± 20 mm



R11 C Grip Sensitech ± 9 mm
R11 C Outdoor Sensitech ± 20 mm



V3 Moderate
Variation

OUTDOOR ± 20 mm Sensitech



± 20 mm
60x120 cm - 23⁵/₈"x47¹/₄"
HCQE Marvel T Navona Sand
HCQF Marvel T Halo Sand
HCQG Marvel T Romano Sand

GRIP SURFACE Sensitech

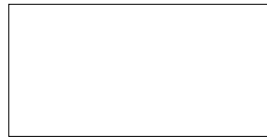

± 9 mm
60x120 cm - 23⁵/₈"x47¹/₄"
HCDC Marvel T Navona Sand
HCDD Marvel T Halo Sand
HCDE Marvel T Romano Sand



NAVONA SAND



HALO SAND

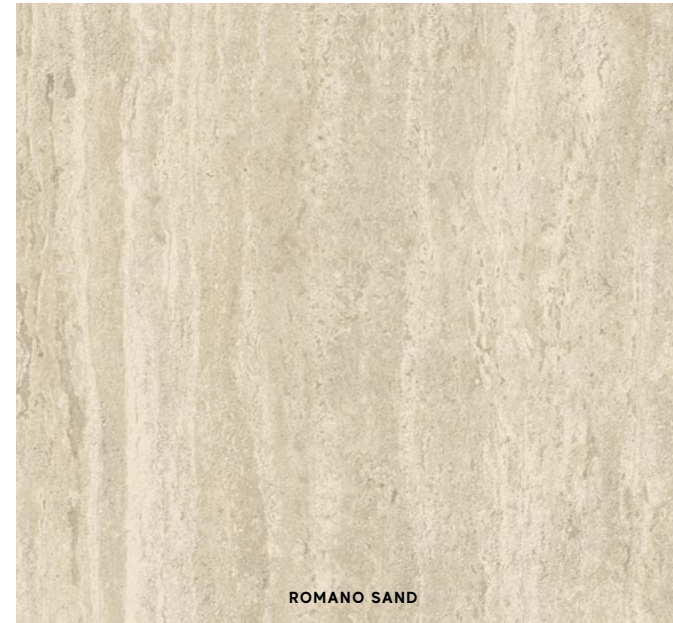

ROMANO SAND

COLLECTION
CATALOG



INDEX



SIZE INDEX



SURFACE
RANGE



IMAGE GALLERY



PRODUCT RANGE



- STONE LOOK
- CONCRETE LOOK
- WOOD LOOK
- MARBLE LOOK

TECHNICAL
SPECIFICATIONS



Marvel Travertine

OUTDOOR ± 20 mm Sensitech



± 20 mm
60x120 cm - 23⁵/₈"x47¹/₄"
AGE7 Marvel Travertine White Vein Cut
AGE8 Marvel Travertine Sand Vein Cut
AGE9 Marvel Travertine Pearl Vein Cut

GRIP SURFACE Sensitech



± 9 mm
60x120 cm - 23⁵/₈"x47¹/₄"
AFUC Marvel Travertine White Vein Cut
AFUD Marvel Travertine Sand Vein Cut
AFUE Marvel Travertine Pearl Vein Cut
AFUH Marvel Travertine White Cross Cut
AFUI Marvel Travertine Sand Cross Cut
AFUJ Marvel Travertine Pearl Cross Cut

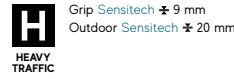

Grip Sensitech ± 9 mm
Outdoor Sensitech ± 20 mm

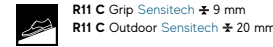

R11 C Grip Sensitech ± 9 mm
R11 C Outdoor Sensitech ± 20 mm



V3 Moderate
Variation

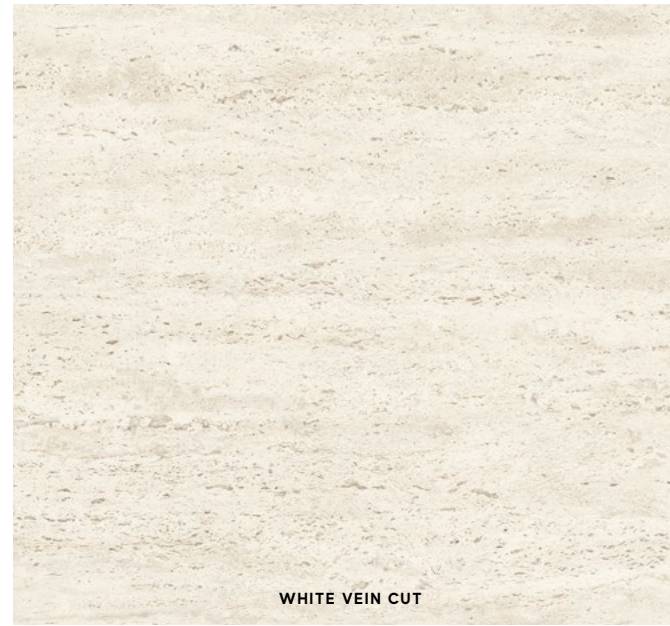

WHITE VEIN CUT



WHITE CROSS CUT



SAND VEIN CUT



SAND CROSS CUT



PEARL VEIN CUT



PEARL CROSS CUT

COLLECTION
CATALOG



INDEX



SIZE INDEX



SURFACE
RANGE



IMAGE GALLERY



PRODUCT RANGE



STONE LOOK
CONCRETE LOOK
WOOD LOOK
MARBLE LOOK

TECHNICAL
SPECIFICATIONS



Safety Requirements

Processing operations such as cutting, grinding and polishing may generate respirable crystalline silica dust.

- Do not handle until all safety precautions have been read, understood and implemented.
- Always use wet methods (apply water) during all fabrication and processing.
- Avoid generating airborne dust, especially without appropriate respiratory protective equipment and adequate air filtration and ventilation systems, which depend on the specific workplace conditions. Air monitoring should be conducted to ensure that respirable crystalline silica levels remain below applicable exposure limits.
- Consult local authorities and a qualified industrial hygienist to implement the required occupational safety measures in compliance with local legislation.
- Refer to the Safety Data Sheet of the product available at <https://www.atlasconcorde.com/en/download-area> for detailed precautions.

Le operazioni di lavorazione come il taglio, la levigatura e la lucidatura possono generare polvere di silice cristallina respirabile.

- Non maneggiare il materiale fino a quando tutte le precauzioni di sicurezza non sono state lette, comprese e implementate.
- Utilizzare sempre metodi a umido (applicare acqua) durante tutte le fasi di lavorazione e fabbricazione.
- Evitare di generare polvere aerea, specialmente senza un adeguato equipaggiamento di protezione respiratoria e sistemi adeguati di filtrazione e ventilazione dell'aria, che dipendono dalle condizioni specifiche del luogo di lavoro. È necessario effettuare monitoraggi dell'aria per garantire che i livelli di silice cristallina respirabile rimangano al di sotto dei limiti di esposizione applicabili.
- Consultare le autorità locali e un igienista industriale qualificato per implementare le misure di sicurezza sul lavoro richieste in conformità con la legislazione locale.
- Fare riferimento alla Scheda di Sicurezza del prodotto disponibile su <https://www.atlasconcorde.com/it/download-area> per le precauzioni dettagliate.

Las operaciones como el corte, esmerilado y pulido pueden generar polvo de sílice cristalina respirable.

- No manipule el producto hasta haber leído, comprendido y aplicado todas las precauciones de seguridad correspondientes.
- Utilice siempre métodos húmedos (aplicación de agua) durante todas las fases de trabajo.
- Evite generar polvo en suspensión, especialmente si no se dispone de equipos de protección respiratoria y sistemas de ventilación/filtración adecuados, cuya idoneidad debe evaluarse según las condiciones específicas del entorno laboral. Se debe realizar un control de calidad del aire para asegurar que los niveles de exposición a la sílice cristalina respirable se mantengan por debajo de los límites permitidos.
- Consulte con las autoridades locales y con un higienista industrial cualificado para implementar las medidas de seguridad necesarias conforme a la normativa local.
- Consulte la Ficha de Datos de Seguridad del producto en: <https://www.atlasconcorde.com/es/download-area> para obtener detalles adición les sobre medidas de seguridad.

Les opérations de traitement telles que la découpe, le meulage et le polissage peuvent générer de la poussière de silice cristalline alvéolaire.

- Ne pas manipuler avant d'avoir lu, compris et appliqué toutes les précautions de sécurité.
- Utiliser toujours des méthodes humides (application d'eau) lors de toutes les étapes de fabrication et de traitement.
- Éviter de générer des poussières en suspension dans l'air, en particulier en l'absence d'un équipement de protection respiratoire approprié et de systèmes adéquats de filtration et de ventilation de l'air, dont l'efficacité dépend des conditions spécifiques du lieu de travail. Une survei lance de l'air doit être effectuée afin de s'assurer que les niveaux de silice cristalline alvéolaire restent inférieurs aux limites d'exposition applicables.
- Consulter les autorités locales ainsi qu'un hygiéniste industriel qualifié pour mettre en oeuvre les mesures de sécurité au travail requises conformément à la législation locale.
- Se référer à la fiche de données de sécurité du produit disponible sur <https://www.atlasconcorde.com/fr/download-area> pour connaître les précautions détaillées.

Bearbeitungen wie das Schneiden, Schleifen und Polieren können lungengängigen Staub aus kristallinem Siliciumdioxid entstehen lassen.

- Das Material darf erst dann verarbeitet werden, wenn alle Vorsichtsmaßnahmen gelesen, verstanden und umgesetzt wurden.
- In allen Bearbeitungs- und Fertigungsphasen stets Nassverfahren (mit Wasser) anwenden.
- Die Entstehung von Staub in der Luft vermeiden, insbesondere dann, wenn keine geeignete Atemschutzausrüstung und keine angemessenen Luftfilter- und Belüftungssysteme zum Einsatz kommen, die von den spezifischen, am Arbeitsplatz herrschenden Bedingungen abhängen. Die Luft muss kontrolliert werden, um sicherzustellen, dass die Konzentration an lungengängigem kristallinem Siliciumdioxid unter den zulässigen Expositionsgrenzen bleibt.
- Wenden Sie sich an die örtlichen Behörden und einen qualifizierten Arbeitshygieniker, um die gemäß den örtlichen Vorschriften erforderlichen Arbeitsschutzmaßnahmen umzusetzen.
- Genauere Vorsichtsmaßnahmen finden Sie im Sicherheitsdatenblatt des Produkts unter <https://www.atlasconcorde.com/de/download-area>

Такие операции обработки материала, как резка, шлифовка и полировка могут приводить к появлению вдыхаемой пыли кристаллического кремния.

- Не работайте с материалом до тех пор, пока все меры безопасности не будут прочитаны, усвоены и внедрены.
- На всех этапах обработки и производства всегда используйте влажные методы (применяйте воду).
- Избегайте образования воздушной пыли, в особенности при отсутствии надлежащих средств защиты дыхательных путей, а также подходящих систем фильтрации и вентиляции воздуха, которые зависят от специальных условий на рабочем месте. Для того чтобы уровни содержания кристаллического кремния во вдыхаемом воздухе находились ниже применимых предельных значений, необходимо осуществлять мониторинг воздуха.
- Обращайтесь в местные органы власти и к квалифицированному специалисту по промышленной гигиене касаясь вопроса внедрения мер безопасности на рабочем месте, требуемых местным законодательством.
- Подробно о мерах предосторожности изложено в паспорте безопасности изделия, с которым можно ознакомиться, перейдя по ссылке <https://www.atlasconcorde.com/ru/download-area>.

Technical Specifications

- ↔ SENSITECH
- ↔ CLEANING AND MAINTENANCE
- ↔ V-SHADE, COLOUR-SHADING
- ↔ TRIM TILES
- ↔ TECHNICAL SPECIFICATIONS
- ↔ RAISED INSTALLATION
- ↔ PACKING

INDEX



SIZE INDEX



SURFACE RANGE



IMAGE GALLERY



PRODUCT RANGE



TECHNICAL SPECIFICATIONS



Responsibility



Circularity

100% of cooked and raw waste recovered internally
 90% recovered waste
 100% water recovered for internal use
 100% recyclable packaging materials

Environment, health and safety

Advanced purification systems, which contribute to the containment of atmospheric emissions
 Reduction of CO₂ emissions due to automated vertical warehouse
 RTO system to reduce harmful emissions and odours
 0% lead, cadmium, and other dangerous substances in products
 All Atlas Concorde surfaces do not release harmful levels of VOCs (Volatile Organic Compounds)

Reduction & self-production of energy

Heat recoveries from industrial furnaces
 Efficient methane gas cogeneration plant
 100% LED light
 Recovery of residual heat energy by tube heat exchangers
 Photovoltaic system producing over 4 GWh annually



For Atlas Concorde, being Made in Italy is not just a prestigious certification of style, design, and production excellence, but an identity that involves all aspects of its business. For this reason, we identify with the values expressed by Confindustria Ceramica's ethical code, which guarantee absolute compliance with labor regulations, and with the marks Made in Italy and Ceramics of Italy, which certify the quality of authentic Italian style.

Certifications

Ratings and memberships

Company certifications

Product certifications

Product declarations

Certification for buildings

Atlas Concorde porcelain tiles and single-fired products can contribute towards earning points needed for LEED® certification.

Certifications for export to international markets*

QB UPEC PORCELAIN TILES

- BOOST
- BOOST BALANCE
- BOOST EXPRESSION
- BOOST ICOR
- BOOST NATURAL
- BOOST NATURAL PRO
- BOOST MINERAL
- BOOST MIX
- BOOST PRO
- BOOST STONE
- BRAVE
- ETIC
- ETIC PRO
- EXENCE
- HEARTWOOD
- LIMS
- LOG
- LOG CANSEI
- MARVEL
- MARVEL DIVA
- MARVEL GEMS
- MARVEL MERA VIGLIA
- MARVEL SHINE
- MARVEL STONE
- MARVEL TRAVERTINE
- MARVEL X
- NORDE

QB UPEC F+ OUTDOOR 20 MM

- BOOST
- BOOST BALANCE
- BOOST NATURAL
- BOOST MINERAL
- BOOST PRO
- BOOST STONE
- BRAVE
- LOG
- NORDE

CLASSIFICATION UPEC/UPEC F+ EN COURS DE CERTIFICATION

- BOOST ICOR
- BOOST EXPRESSION
- BOOST VISION
- MARVEL T
- NYRA

* Valid certification for porcelain tile and wall tiles. - Certificazione valida per prodotti in gres porcellanato e rivestimenti.

* Shipments can be made in accordance with national requirements anywhere in the world, even in markets with complex customs procedures such as Egypt, Morocco and Kurdistan, thanks to our active cooperation with accredited certification bodies in each country. - Possibilità di spedizioni conformi alle prescrizioni nazionali ovunque nel mondo, anche in mercati con procedure doganali complesse come Egitto, Marocco, Kurdistan, grazie alla collaborazione sempre attiva con gli enti di certificazione accreditati in ciascun paese. - Dank unserer aktiven Zusammenarbeit mit den akkreditierten Zertifizierungsstellen in den einzelnen Ländern können die Sendungen in Übereinstimmung mit den nationalen Anforderungen überall auf der Welt versandt werden, selbst auf Märkten mit komplexen Zollverfahren wie Ägypten, Marokko und Kurdistan. - Possibilità d'expéditions conformes aux prescriptions nationales partout dans le monde, même sur les marchés dont les procédures douanières sont complexes comme l'Égypte, le Maroc ou le Kurdistan, grâce à la collaboration toujours active avec les organismes de certification homologués dans chaque pays. - Se pueden realizar envíos según la normativa nacional a cualquier parte del mundo, incluso a mercados con procedimientos aduaneros complejos como Egipto, Marruecos o Kurdistan, gracias a la cooperación permanente con los organismos de certificación acreditados en cada país. - Компания имеет возможность осуществлять поставки в любую точку мира в соответствии с национальными требованиями, даже на рынках со сложными таможенными процедурами, таких как Египет, Марокко, Курдистан, благодаря неизменно активному сотрудничеству с аккредитованными органами сертификации в каждой стране.

⁽¹⁾ Classificazione UPEC aggiornata al - Classement UPEC mis à jour en: Décembre 2025

⁽²⁾ Si consiglia la consultazione della pagina - On vous conseille de vous connecter à: <https://database.cstb.fr/holderdetails?UId=ETB-2094&AppRef=QB32>

⁽³⁾ Per ulteriori informazioni scrivere a - Pour tous renseignements complémentaires merci d'écrire à: france@atlasconcorde.it

INDEX



SIZE INDEX



SURFACE RANGE



IMAGE GALLERY



PRODUCT RANGE



TECHNICAL SPECIFICATIONS



Sensitech

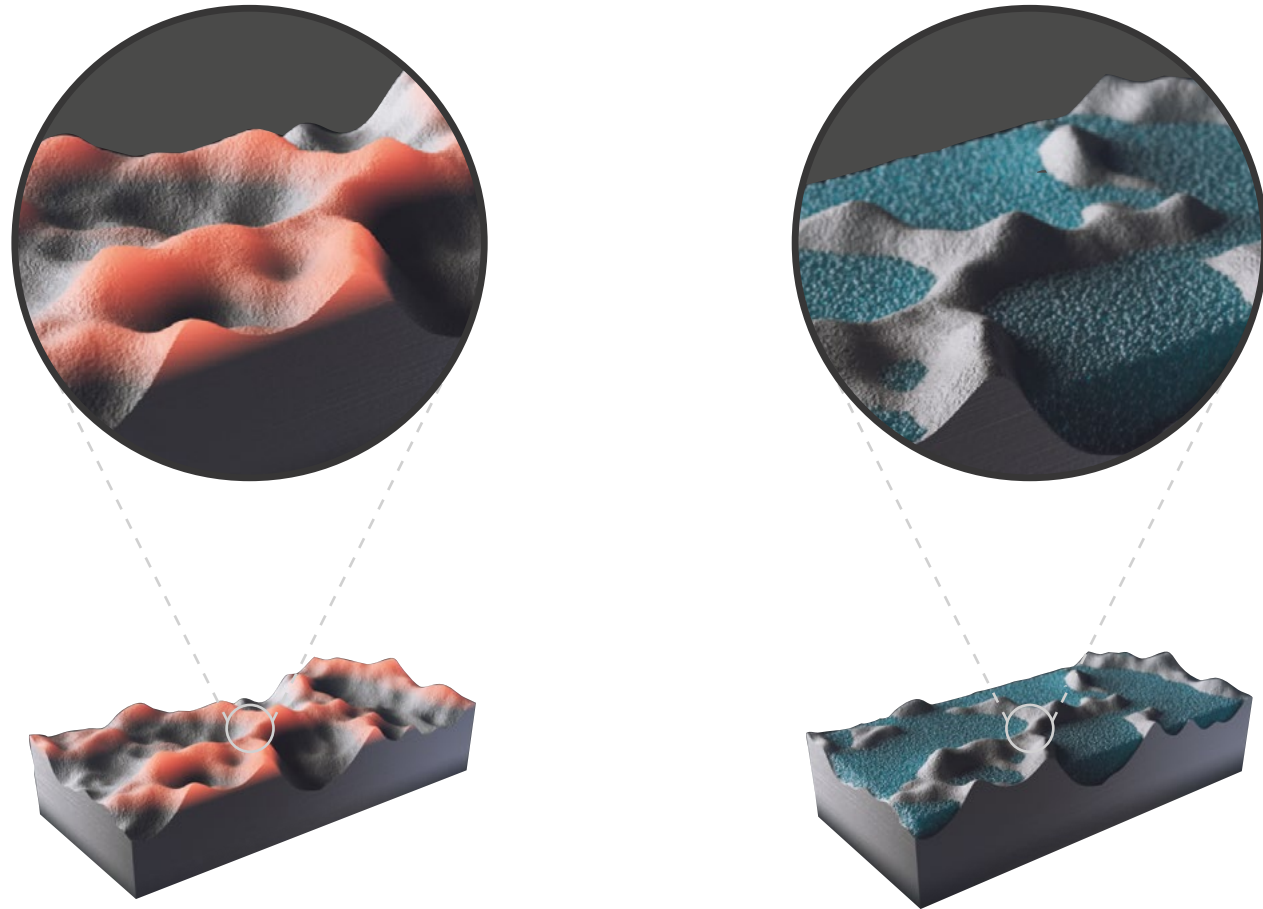

Traditional anti-slip surface

The innovative Sensitech Surface

Sensitech is the high-tech surface for indoor and outdoor settings created by Atlas Concorde Laboratories, patented in Europe, in the United States and in Russia. The surface combines high slip resistance performance with tactile softness. With Sensitech, the meaning of surface evolves and takes on a reassuring, pleasant and practical touch, making architectural spaces more comfortable and appealing.

Sensitech è la superficie ad alto coefficiente tecnologico per gli ambienti interni ed esterni realizzata dai Laboratori Atlas Concorde, brevettata in Europa, negli Stati Uniti e in Russia. La superficie coniuga elevate prestazioni di resistenza allo scivolamento ad una maggiore morbidezza tattile. Con Sensitech il significato di superficie si evolve e assume un tocco rassicurante, piacevole e pratico, rendendo gli spazi architettonici sempre più confortevoli e appaganti.



Precautions for cleaning and maintenance

Precauzioni sulla pulizia e manutenzione . Hinweise zur Pflege und Reinigung . Précautions sur le nettoyage et l'entretien . Precauciones sobre la limpieza y manutención . Чистка и уход

Cleaning and maintenance procedures can be carried out using a common neutral detergent and a direct water jet: the draining power of inclined surfaces and the presence of open joints between slabs encourages the collection of dirt near the discharge points. For large surfaces, it is recommended the use of a washer-dryer and single-brush machines with soft nylon brushes. Please note that a water patina, due to the surface tension feature of liquids, will tend to form on any outdoor surface even when inclined properly. To remove this patina and obtain the complete drying of the floor, it is recommended to push the water towards joints using a scrubbing-brush or to use a wet and dry vacuum cleaner. To make square or perpendicular cuts it's best to first drill circular holes near the corners of the hole and then connect them with linear cuts, which will relax the tension at the corners of the tile. The mechanical properties indicated in the data sheet refer to the whole formats in the Atlas Concorde Outdoor Catalog that have not been cut or modified.

Le operazioni di pulizia e manutenzione possono essere eseguite con un normale detergente neutro e un getto diretto di acqua: le capacità drenanti delle superfici in pendenza e la presenza di fughe aperte tra le lastre consentono infatti di convogliare lo sporco verso i punti di scarico. Per grandi superfici è consigliabile l'utilizzo di macchine lavasciuga e monospazzole con setole in nylon morbide. Si tenga inoltre presente che su qualunque superficie per esterni, seppur posata in opportuna pendenza, tende a formarsi sul bordo della superficie una leggera patina di acqua per via dell'effetto di tensione superficiale dei liquidi. Per eliminare questa patina e ottenere l'asciugatura completa e corretta del pavimento, si consiglia di spingere l'acqua con uno spazzolone verso la direzione delle fughe o di utilizzare un aspiraliquidi. Per eseguire tagli quadrati o squadri si consiglia di eseguire inizialmente fori circolari in prossimità dei vertici del taglio e collegarli in un secondo momento attraverso tagli lineari, in questo modo si avrà un rilassamento delle tensioni sui vertici della piastrina tagliata. Le caratteristiche meccaniche massime indicate nella scheda tecnica si riferiscono ai formati interi presenti sul Catalogo Outdoor Atlas Concorde e che non abbiano subito tagli o altre trasformazioni.

Die Reinigung und Pflege kann mit einem normalen Reinigungsmittel und direktem Wasserstrahl durchgeführt werden: die Drainageleistung von geneigten Flächen und das Vorhandensein von Hohlspalten zwischen den Platten leiten den Schmutz dem Abflusssystem zu. Für große Flächen empfiehlt sich der Einsatz von Reinigungsmaschinen und Bürsten mit weichen Nylonborsten. Wir weisen auch darauf hin, dass sich auf jeder Oberfläche für den Außenbereich, auch wenn sie mit einem ausreichenden Gefälle verlegt worden ist, durch die Wirkung der Oberflächenspannung von Flüssigkeiten am Rand der Oberfläche eine dünne Wasserschicht bildet. Um diese zu beseitigen und für die vollständige und korrekte Trocknung des Bodens empfehlen wir das Wasser mit einer Bürste in Richtung Fugen zu schieben oder einen Flüssigkeitssauger zu verwenden.

Für quadratische oder lotrechte Schnitte empfiehlt es sich, zunächst an den Eckpunkten des Ausschnitts kreisförmige Bohrungen auszuführen und diese anschließend durch lineare Schnitte zu verbinden. Auf diese Weise werden die Spannungen an den Ecken der geschnittenen Fliese abgebaut. Die im Datenblatt aufgeführten mechanischen Eigenschaften der Fliesenmasse beziehen sich auf ganze Formate aus dem Outdoor-Katalog von Atlas Concorde, die nicht geschnitten oder anderweitig bearbeitet wurden.

Les opérations de nettoyage et d'entretien peuvent être effectuées avec un détergent neutre normal et un jet d'eau direct : les capacités drainantes des surfaces en pente et la présence de joints ouverts entre les dalles permettent en effet de diriger les saletés vers les points d'évacuation. Pour des grandes surfaces, nous conseillons d'utiliser des aspirateurs nettoyeurs et des monobrosses équipées de brosses en poils nylon souples. Il convient également de noter que sur toute surface pour l'extérieur non convenablement posée en pente, une légère patine d'eau a tendance à se former à cause de l'effet de tension des liquides en surface. Pour éliminer cette patine et obtenir le séchage complet et correct du sol, nous conseillons de pousser l'eau à l'aide d'une brosse à carrelage en direction des joints ou d'utiliser un aspirateur à liquide. Pour réaliser des découpes à angle droit ou biseautées, il est conseillé de commencer par effectuer des trous circulaires en proximité des bords de la découpe, puis, dans un second temps, de les relier par des découpes linéaires, ce qui permettra d'obtenir une relaxation des contraintes au niveau des bords du carreau découpé. Les caractéristiques mécaniques massives indiquées sur la fiche technique se réfèrent aux formats entiers présents dans le Catalogue Outdoor Atlas Concorde qui n'ont subi aucune découpe ni autres transformations.

Las operaciones de limpieza y manutención pueden ser efectuadas con un normal detergente neutro y un chorro directo de agua: las capacidades drenantes de las superficies inclinadas y la presencia de juntas abiertas entre las losas permiten de hecho encauzar la suciedad hacia los puntos de descarga. Para grandes superficies es aconsejable el empleo de máquinas lavadora-secadora y rotativa pulidora con cerdas de nylon suaves. Además hay que tener presente que sobre cualquier superficie para exteriores, si no es colocada con una inclinación oportuna, en el borde de la superficie tiende a formarse una ligera patina de agua producto del efecto de tensión superficial de los líquidos. Para eliminar esta película y conseguir el secado completo y correcto del pavimento, se aconseja empujar el agua con una escoba en dirección de las juntas o emplear un aspira líquidos. Para realizar cortes cuadrados o rectangulares se recomienda realizar inicialmente agujeros circulares próximos a los vértices del corte y unirlos posteriormente mediante cortes lineales. De esta forma se relajan las tensiones en los vértices de la baldosa cortada. Las características mecánicas masivas indicadas en la ficha técnica se refieren a los tamaños enteros que figuran en el Catálogo Atlas Concorde Outdoor y que no han sido sujetos a cortes u otras transformaciones.

Чистку плиток можно выполнять нейтральным моющим средством и прямой струей воды: дренажные способности наклонной поверхности и наличие открытых швов между плитками обеспечивают отвод грязной воды к стокам. Для больших поверхностей рекомендуется использовать полаяющие машины или однодисковые полотеры с мягкими нейлоновыми щетками. Следует иметь в виду, что на наружных покрытиях, уложенных без надлежащего уклона, в силу явления поверхностного натяжения жидкостей может образоваться тонкая водная пленка. Для ее удаления и полного высушивания покрытия рекомендуется согнать воду щеткой-шваброй в сторону швов или использовать водосос. Для выполнения квадратных или прямоугольных отверстий рекомендуется сначала просверлить круглые отверстия в каждом углу участка реза, затем соединить эти отверстия прямолинейной резкой. Это поможет ослабить напряжения по углам прорезаемого отверстия. Механические характеристики черепка плитки, указанные в технических характеристиках, относятся к целым, не подвергнутым резке или другому рода обработке форматам, представленным в каталоге Outdoor Atlas Concorde.

V-shade colour-shading

Stonalizzazione V-SHADE . Denuancement, V-SHADE . V-SHADE, Marmorierung . Contraste, V-SHADE . Цветовое отличие, V-SHADE



V1
Uniform appearance
Aspetto uniforme
Aspect uniforme
Gleichmäßiges Erscheinungsbild
Aspecto uniforme
Однородный вид



V2
Slight variation
Variazione minima
Variation minimale
Leichte Abweichung
Variación mínima
Минимальная Неоднородность



V3
Moderate variation
Variazione moderata
Variation Modérée
Mäßige Abweichung
Variación moderada
Умеренная Неоднородность



V4
Substantial variation
Variazione sostanziale
Variation substantielle
Grundlegende Abweichung
Variación sustancial
Значительная Неоднородность

The V-Shade classification indicates the colour shading level of a product, that is to say the chromatic and/or surface variation among tiles of the same collection.

La classification VShade indique le niveau de gradation du produit, c'est-à-dire de variation chromatique et/ou superficielle entre des dalles d'une même collection.

La clasificación V-Shade indica el nivel de variación de tono del producto, o de variación cromática y/o superficial que existe entre las baldosas de una misma colección.

La classificazione VShade indica il livello di stonalizzazione del prodotto, ovvero di variazione cromatica e/o superficiale che intercorre tra le piastrelle di una stessa collezione.

Die Klassifizierung V-Shade gibt das Niveau des Farbverlaufs des Produktes oder die Abweichung des Farbtons und/oder Oberfläche unter den Fliesen der gleichen Kollektion an.

Классификация V-Shade указывает на уровень цветовой или фактурной неоднородности плиток, т.е.

INDEX



SIZE INDEX



SURFACE RANGE



IMAGE GALLERY



PRODUCT RANGE



TECHNICAL SPECIFICATIONS



Trim Tiles / Pezzi Speciali

≡ 20 mm

			BOOST	BOOST BALANCE	BOOST EXPRESSION	BOOST ICOR	BOOST MINERAL	BOOST MIX	BOOST NATURAL	BOOST NATURAL PRO	BOOST PRO	BOOST STONE	BOOST VISION	BRAVE	ENTICE	ETIC PRO	EXENCE	LIMS	LOG	LOG SELECT	MARVEL MERAVIGLIA	MARVEL X	MARVEL T	MARVEL TRAVERTINE	NORDE	NYRA
Lineare	30x60 cm	11 ³ / ₄ "x23 ⁵ / ₈ "	•																							
	33x120 cm	13"x47 ¹ / ₄ "	•	•	•	•	•	•	•	•	•	•	•	•								•	•	•	•	•
	30x120 cm	11 ³ / ₄ "x47 ¹ / ₄ "														•	•	•		•						
Round	60x90 cm	23 ⁵ / ₈ "x35 ³ / ₈ "					•																			•
	40x80 cm	15 ³ / ₄ "x31 ¹ / ₂ "	•			•					•															•
	30x60 cm	11 ³ / ₄ "x23 ⁵ / ₈ "	•	•	•	•	•	•	•	•	•	•	•	•												•
Round Angolare Dx/Sx	33x120 cm	13"x47 ¹ / ₄ "	•	•	•	•	•	•	•	•	•	•	•	•												•
	30x120 cm	11 ³ / ₄ "x47 ¹ / ₄ "														•	•	•		•						•
	60x90 cm	23 ⁵ / ₈ "x35 ³ / ₈ "					•																			•
	40x80 cm	15 ³ / ₄ "x31 ¹ / ₂ "	•			•					•															•
Round	60x60 cm	23 ⁵ / ₈ "x23 ⁵ / ₈ "	•				•	•	•	•	•	•	•													•
Round Angolare	60x60 cm	23 ⁵ / ₈ "x23 ⁵ / ₈ "	•				•	•	•	•	•	•	•													•
Gradino Round	30x60 cm	11 ³ / ₄ "x23 ⁵ / ₈ "	•	•	•	•	•	•	•	•	•	•	•	•												•
Gradino Round Ang. Dx/Sx	30x60 cm	11 ³ / ₄ "x23 ⁵ / ₈ "	•	•	•	•	•	•	•	•	•	•	•	•												•
Elemento L	33x120 cm	13"x47 ¹ / ₄ "	•	•	•	•	•	•	•	•	•	•	•	•												•
	30x120 cm	11 ³ / ₄ "x47 ¹ / ₄ "														•	•	•		•						•
	33x90 cm	13"x35 ³ / ₈ "					•																			•
	33x80 cm	13"x31 ¹ / ₂ "	•	•	•						•															•
	20x60 cm	7 ⁷ / ₈ "x23 ⁵ / ₈ "	•				•	•	•	•	•	•	•	•												•
Elemento L Angolare	33x33 cm	13"x13"	•	•	•	•	•	•	•	•	•	•	•	•												•
	20x20 cm	7 ⁷ / ₈ "x7 ⁷ / ₈ "	•				•	•	•	•	•	•	•	•												•
Alzata	30x120 cm	11 ³ / ₄ "x47 ¹ / ₄ "														•	•	•		•						•
	20x120 cm	7 ⁷ / ₈ "x47 ¹ / ₄ "	•	•	•	•	•	•	•	•	•	•	•	•												•
	20x80 cm	7 ⁷ / ₈ "x31 ¹ / ₂ "	•	•	•						•															•
	20x90 cm	7 ⁷ / ₈ "x35 ³ / ₈ "					•																			•
Top	30x120 cm	11 ³ / ₄ "x47 ¹ / ₄ "	•				•	•	•	•	•	•	•	•												•
	30x60 cm	11 ³ / ₄ "x23 ⁵ / ₈ "	•				•	•	•	•	•	•	•	•												•
Costa Design	33x120 cm	13"x47 ¹ / ₄ "	•				•	•	•	•	•	•	•													•
Bordo Piscina	30x60 cm	11 ³ / ₄ "x23 ⁵ / ₈ "	•	•	•	•	•	•	•	•	•	•	•	•												•
Bordo Piscina Ang. Dx/Sx	30x60 cm	11 ³ / ₄ "x23 ⁵ / ₈ "	•	•	•	•	•	•	•	•	•	•	•	•												•
Griglia	20x60 cm	7 ⁷ / ₈ "x23 ⁵ / ₈ "	•	•	•	•	•	•	•	•	•	•	•	•												•
	15x60 cm	5 ⁷ / ₈ "x23 ⁵ / ₈ "	•	•	•	•	•	•	•	•	•	•	•	•												•
Griglia Angolare Dx/Sx	20x60 cm	7 ⁷ / ₈ "x23 ⁵ / ₈ "	•	•	•	•	•	•	•	•	•	•	•	•												•
	15x60 cm	5 ⁷ / ₈ "x23 ⁵ / ₈ "	•	•	•	•	•	•	•	•	•	•	•	•												•
Curve	60x60 cm	23 ⁵ / ₈ "x23 ⁵ / ₈ "	•	•	•	•	•	•	•	•	•	•	•													•
Smussato	30x60 cm	11 ³ / ₄ "x23 ⁵ / ₈ "	•	•	•	•	•	•	•	•	•	•	•	•												•

Trim Tiles / Pezzi Speciali

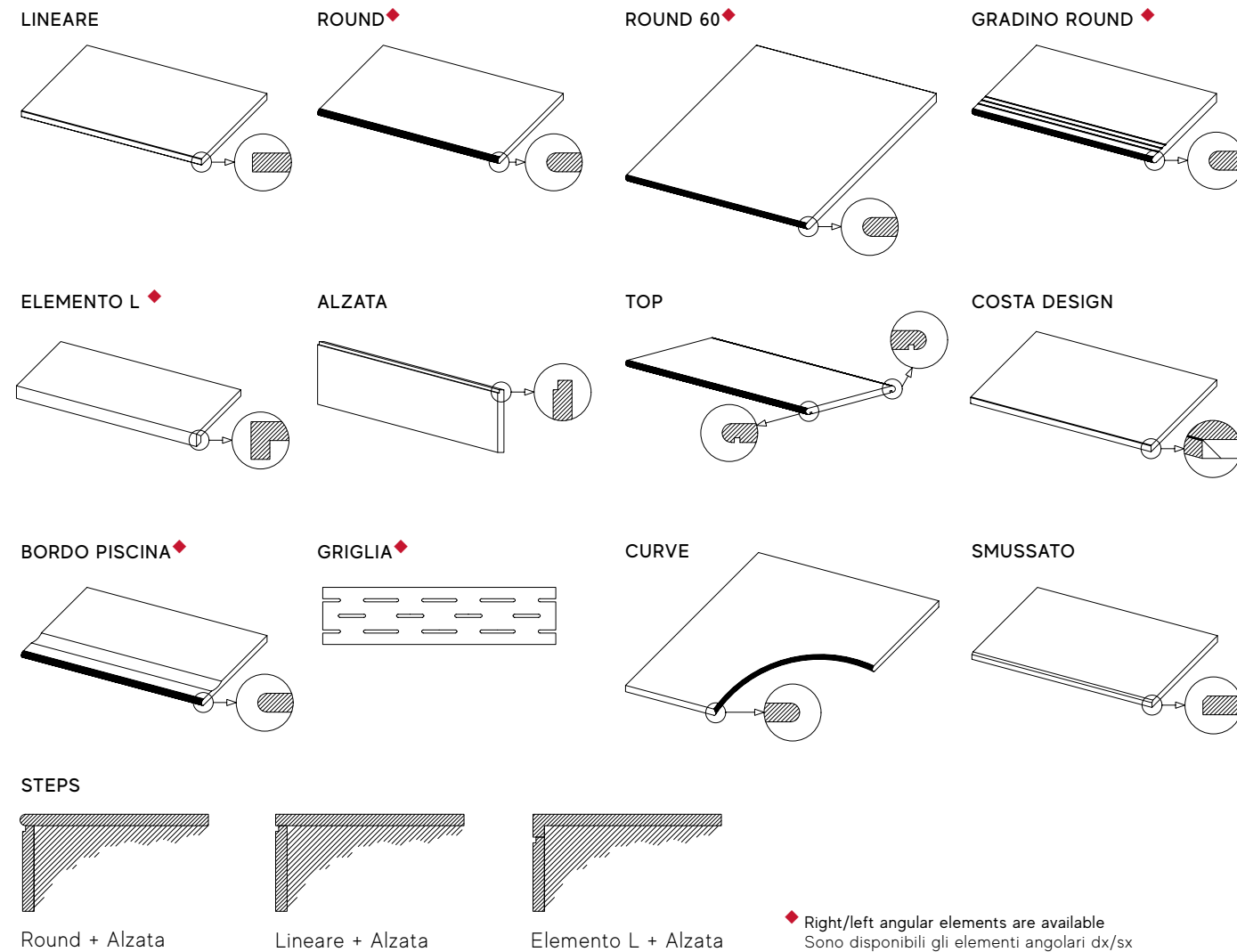

◆ Right/left angular elements are available
Sono disponibili gli elementi angolari dx/sx

≡ 9 mm Grip

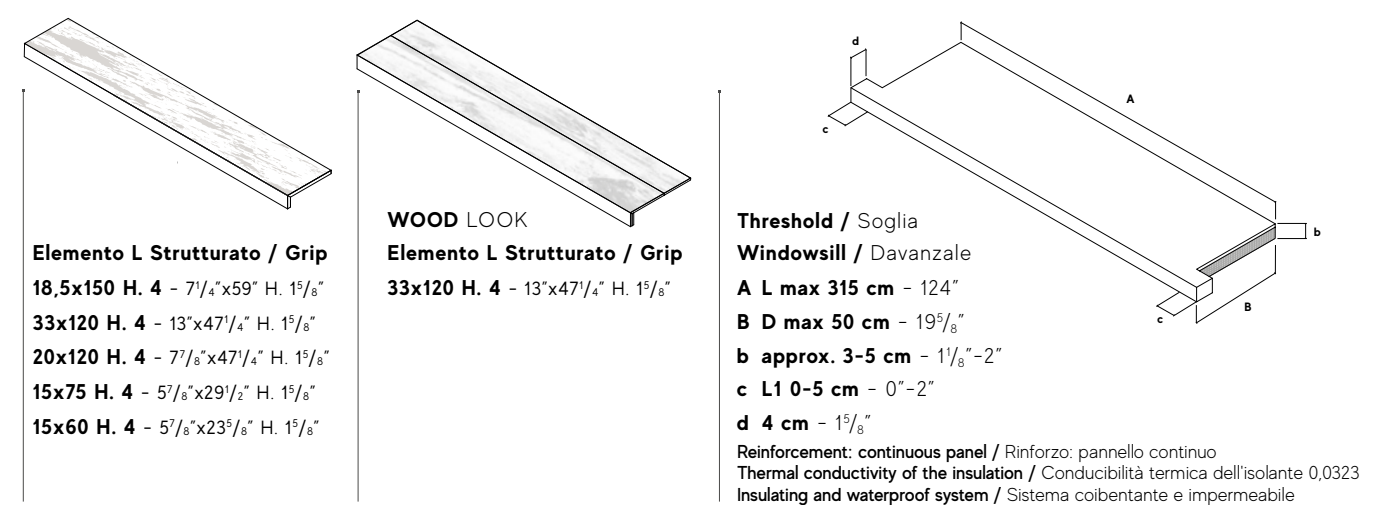

Elemento L Strutturato / Grip
 18,5x150 H. 4 - 7¹/₄"x59" H. 1⁵/₈"
 33x120 H. 4 - 13"x47¹/₄" H. 1⁵/₈"
 20x120 H. 4 - 7⁷/₈"x47¹/₄" H. 1⁵/₈"
 15x75 H. 4 - 5⁷/₈"x29¹/₂" H. 1⁵/₈"
 15x60 H. 4 - 5⁷/₈"x23⁵/₈" H. 1⁵/₈"

WOOD LOOK
Elemento L Strutturato / Grip
 33x120 H. 4 - 13"x47¹/₄" H. 1⁵/₈"

Threshold / Soglia
Windowsill / Davanzale
A L max 315 cm - 124"
B D max 50 cm - 19⁵/₈"
b approx. 3-5 cm - 1¹/₈"-2"
c L1 0-5 cm - 0"-2"
d 4 cm - 1⁵/₈"
 Reinforcement: continuous panel / Rinforzo: pannello continuo
 Thermal conductivity of the insulation / Conducibilità termica dell'isolante 0,0323
 Insulating and waterproof system / Sistema coibente e impermeabile

INDEX



SIZE INDEX



SURFACE RANGE



IMAGE GALLERY



PRODUCT RANGE



TECHNICAL SPECIFICATIONS



Technical Features

≡ 20 mm

Caratteristiche tecniche . Technische Daten . Caractéristiques techniques . Características técnicas . Технические характеристики
 Compliant with standards EN 14411 annex G group Bla . Conforme alla norma EN 14411 Appendice G gruppo Bla . Compliant with standards ISO 13006 annex G group Bla . Conforme alla norma ISO 13006 Appendice G gruppo Bla

			Requirements for nominal size N Requisiti per dimensione nominale N			20 mm	
			7 cm ≤ N < 15 cm (mm)	N ≥ 15 cm (%) (mm)			
Regularity characteristics	Length and width Lunghezza e larghezza	ISO 10545-2	± 0,9 (*)	± 0,6 (*)	± 2,0 (*)	± 0,3 ± 1,0 mm	
			± 0,5 (**)	± 5 (**)	± 0,5 (**)	± 5,0 ± 0,5 mm	
	Thickness Spessore	ISO 10545-2	± 0,75 (***)	± 0,5 (***)	± 1,5 (***)	± 0,3 ± 0,8 mm	
			± 0,75 (***)	± 0,5 (***)	± 2,0 (***)	± 0,3 ± 1,5 mm	
Straightness of sides Rettilineità degli spigoli	ISO 10545-2	c.c. ± 0,75	c.c. ± 0,5	c.c. ± 1,8	Suitable for Conforme		
		e.c. ± 0,75	e.c. ± 0,5	e.c. ± 1,8			
Rectangularity (Measurement only on short edges when L/l ≥ 3) Ortogonalità (Misurazione da condurre solo sui lati corti quando L/l ≥ 3)	ISO 10545-2	w. ± 0,75	w. ± 0,5	w. ± 1,8	Suitable for Conforme		
		e.c. ± 0,75	e.c. ± 0,5	e.c. ± 1,8			
Surface flatness Planarità	ISO 10545-2	w. ± 0,75	w. ± 0,5	w. ± 1,8	Suitable for Conforme		
		e.c. ± 0,75	e.c. ± 0,5	e.c. ± 1,8			
Structural characteristics	Water absorption Massa d'acqua assorbita	ISO 10545-3	EN 14411 annex G (Group Bla) EN 14411 appendice G (Gruppo Bla)			ISO 13006 annex G (Group Bla) ISO 13006 appendice G (Gruppo Bla)	≤ 0,1 %
		ASTM C373	Requirement ANSI A137.1 Water Absorption Max ≤ 0,5% ± 0,5%				≤ 0,5 %
Bulk mechanical characteristics	Breaking strength Sforzo di rottura	ISO 10545-4	S ≥ 1300 N			S ≥ 10000 N	
		ISO 10545-4	R ≥ 35 N/mm²			R ≥ 45 N/mm²	
Bulk mechanical characteristics	Modulus of rupture Resistenza alla flessione	EN 1339 Annex F	-			For specific values check the table on the side Per i valori specifici controllare la tabella a lato	
		ISO 10545-5	Declared value Dichiarare un valore	Test method available Metodo di prova disponibile	≥ 0,55		
Surface mechanical characteristics	Impact resistance, as coefficient of restitution Resistenza all'impatto, espresso come coefficiente di restituzione	ISO 10545-5	Declared value Dichiarare un valore	Test method available Metodo di prova disponibile	≥ 0,55		
		ISO 10545-6	≤ 175 mm³			≤ 150 mm³	
Surface mechanical characteristics	Resistance to deep abrasion of unglazed tiles (removed volume) Resistenza all'abrasione profonda delle piastrelle non smaltate (volume materiale asportato)	ISO 10545-6	≤ 175 mm³			≤ 150 mm³	
		ISO 10545-8	Declared value Dichiarare un valore	Test method available Metodo di prova disponibile	≤ 7 MK ⁻¹		
Thermal and hygrometric characteristics	Coefficient of thermal linear expansion Coefficiente di dilatazione termica lineare	ISO 10545-8	Declared value Dichiarare un valore	Test method available Metodo di prova disponibile	≤ 7 MK ⁻¹		
		ISO 10545-9	Pass according to ISO 10545-1 Test superato in accordo con ISO 10545-1	Test method available Metodo di prova disponibile	Resistant Resiste		
Thermal and hygrometric characteristics	Thermal shock resistance Resistenza agli sbalzi termici	ISO 10545-9	Pass according to ISO 10545-1 Test superato in accordo con ISO 10545-1	Test method available Metodo di prova disponibile	Resistant Resiste		
		ISO 10545-10	Declared value Dichiarare un valore	Test method available Metodo di prova disponibile	≤ 0,01% (0,1mm/m)		
Thermal and hygrometric characteristics	Moisture expansion (in mm/m) Dilatazione all'umidità (in mm/m)	ISO 10545-10	Declared value Dichiarare un valore	Test method available Metodo di prova disponibile	≤ 0,01% (0,1mm/m)		
		ISO 10545-12	Pass according to ISO 10545-1 Test superato in accordo con ISO 10545-1	Required Metodo di prova richiesto	Resistant Resiste		
Physical properties	Frost resistance Resistenza al gelo	ISO 10545-12	Pass according to ISO 10545-1 Test superato in accordo con ISO 10545-1	Required Metodo di prova richiesto	Resistant Resiste		
		EN 12004-2	Declared value Dichiarare un valore	-	≥ 1,0 N/mm² (Class C2 - EN 12004)		
Physical properties	Reaction to fire Reazione al fuoco	-	Class A1 or A1 _s Classe A1 oppure A1 _s	-	A1 - A1 _s		
		ISO 10545-13	Declared value Dichiarare una Classe	Manufacturer is to state classification Secondo la classificazione indicata dal fabbricante	LA		
Chemical characteristics	Resistance to low concentrations of acids and alkalis Resistenza a basse concentrazioni di acidi e alcali	ISO 10545-13	Declared value Dichiarare una Classe	Manufacturer is to state classification Secondo la classificazione indicata dal fabbricante	LA		
		ISO 10545-13	Declared value Dichiarare una Classe	Declared value Dichiarare una Classe	HA		
Chemical characteristics	Resistance to high concentrations of acids and alkalis Resistenza ad alte concentrazioni di acidi e alcali	ISO 10545-13	Declared value Dichiarare una Classe	Declared value Dichiarare una Classe	HA		
		ISO 10545-14	Declared value Dichiarare una Classe	Declared value Dichiarare una Classe	5		
Safety characteristics (*)	Resistance to staining, for unglazed tiles Resistenza alle macchie per piastrelle non smaltate	ISO 10545-14	Declared value Dichiarare una Classe	Declared value Dichiarare una Classe	5		
		DIN EN 16165 ANNEX B (EX DIN 51130)	Declared value Dichiarare un valore	-	R11 Boost, Boost Mix, Boost Balance, Boost Mineral, Boost Natural, Boost Pro, Boost Stone, Exence, Lims, Log Select, Marvel T, Marvel Travertine, Norde, Nyra		
Safety characteristics (*)	Shod Ramp Test Metodo della rampa "calzato"	DIN EN 16165 ANNEX B (EX DIN 51130)	Declared value Dichiarare un valore	-	R11 Boost, Boost Mix, Boost Balance, Boost Mineral, Boost Natural, Boost Pro, Boost Stone, Exence, Lims, Log Select, Marvel T, Marvel Travertine, Norde, Nyra		
		DIN EN 16165 ANNEX A (EX DIN 51097)	Declared value Dichiarare un valore	-	A+B+C Boost, Boost Balance, Boost Mineral, Boost Mix, Boost Natural, Boost Pro, Boost Stone, Boost Vision, Exence, Lims, Log Select, Marvel T, Marvel Travertine, Norde, Nyra		
Safety characteristics (*)	Barefoot Ramp Test Metodo della rampa a piedi nudi	DIN EN 16165 ANNEX A (EX DIN 51097)	Declared value Dichiarare un valore	-	A+B+C Boost, Boost Balance, Boost Mineral, Boost Mix, Boost Natural, Boost Pro, Boost Stone, Boost Vision, Exence, Lims, Log Select, Marvel T, Marvel Travertine, Norde, Nyra		
		BS EN 16165 ANNEX C (EX BS 7976)	Declared value Dichiarare un valore	-	PVT > 36 Dry PVT > 36 Wet		
Safety characteristics (*)	Pendulum Friction Test Metodo del Pendolo	AS 4586	PTV ≥ 36 classifies the surface as "low slip risk"			≥ 36 Dry ≥ 36 Wet	
		UNE EN 16165 ANNEX C (EX UNE 41901 EX:2017)	Declared value Dichiarare un valore	-	Class P4		
Safety characteristics (*)	Coefficient of friction (COF) Coefficiente di attrito	B.C.R.A. Rep. CEC/81	D. M. 236/89 del 14/06/89 μ > 0,40 per elemento scivolante gomma dura su pavimentazione bagnata μ > 0,40 per elemento scivolante cuoio su pavimentazione asciutta			> 0,40 Asciutto > 0,40 Bagnato	
		ANSI A 326.3	-	-	> 0,55 Wet		

Physical-mechanical features in accordance with EN 1339 Caratteristiche fisiche-meccaniche secondo EN 1339		
Technical feature Caratteristica tecnica	EN 1339 standard Norma EN 1339	Performance of slab Prestazione Lastra
Water absorption Assorbimento d'acqua	Annex E Appendice E	< 0,1%
Bending strength Resistenza alla flessione	Annex F Appendice F	Marking/Marcatura ≥ T11 60x60 Marking/Marcatura ≥ U11 80x80 Marking/Marcatura ≥ U4 60x90
Breaking load Carico di rottura	Annex F Appendice F	Marking/Marcatura ≥ U3 30x120 Marking/Marcatura ≥ U4 60x120 Marking/Marcatura ≥ T11 120x120
Frost resistant in presence of de frosting salts Resistenza al gelo in presenza di Sali Disgelanti	Annex D Appendice D	Resistant Resiste

Mechanical features with raised installation in accordance with EN 12825 Caratteristiche meccaniche posa sopraelevata secondo EN 12825	
Static load capacity Carico Statico	Average performance of slab (kN) Prestazione Media Lastra (kN)
Centre Centro	≥ 5,5 60x60x2 / ≥ 5,5 80x80x2 / ≥ 4,0 60x120x2 / ≥ 7,0 kN 120x120x2
Side centre Centro Lato	≥ 5,0 kN 60x60x2 / ≥ 5,5 80x80x2 / ≥ 4,5 kN 60x120x2 / ≥ 4,5 kN 120x120x2
Diagonal Diagonale	≥ 5,5 kN 60x60x2 / ≥ 5,5 80x80x2 / 6,0 kN 60x120x2 / ≥ 5,5 kN 120x120x2



Technical Features

≡ 9 mm

Caratteristiche tecniche . Technische Daten . Caractéristiques techniques . Características técnicas . Технические характеристики
 Compliant with standards EN 14411 annex G group Bla . Conforme alla norma EN 14411 Appendice G gruppo Bla - Compliant with standards ISO 13006 annex G group Bla . Conforme alla norma ISO 13006 Appendice G gruppo Bla

			Requirements for nominal size N Requisiti per dimensione nominale N			GRIP Brave, Boost, Boost Balance, Boost Expression, Boost Icor, Boost Mix, Boost Mineral, Boost Natural, Boost Natural Pro, Boost Pro, Boost Stone, Boost Vision, Exence, Lims, Log, Log Cansei, Log Select, Marvel T, Marvel Travertine, Norde, Nyra	
			7 cm ≤ N < 15 cm (mm)	N ≥ 15 cm (%) (mm)			
Regularity characteristics	Length and width Lunghezza e larghezza	ISO 10545-2	± 0,9 (*)	± 0,6 (*)	± 2,0 (*)	Suitable for Conforme	
			± 0,5 (**)	± 5 (**)	± 0,5 (**)	Suitable for Conforme	
	Thickness Spessore	ISO 10545-2	± 0,75 (***)	± 0,5 (***)	± 1,5 (***)	Suitable for Conforme	
			± 0,75 (***)	± 0,5 (***)	± 2,0 (***)	± 0,3 % ± 1,5 mm	
Straightness of sides Rettilineità degli spigoli	ISO 10545-2	c.c. ± 0,75	c.c. ± 0,5	c.c. ± 1,8	Suitable for Conforme		
		e.c. ± 0,75	e.c. ± 0,5	e.c. ± 1,8			
Rectangularity (Measurement only on short edges when L/l ≥ 3) Ortogonalità (Misurazione da condurre solo sui lati corti quando L/l ≥ 3)	ISO 10545-2	w. ± 0,75	w. ± 0,5	w. ± 1,8	Suitable for Conforme		
		e.c. ± 0,75	e.c. ± 0,5	e.c. ± 1,8			
Surface flatness Planarità	ISO 10545-2	w. ± 0,75	w. ± 0,5	w. ± 1,8	Suitable for Conforme		
		e.c. ± 0,75	e.c. ± 0,5	e.c. ± 1,8			
Structural characteristics	Water absorption Massa d'acqua assorbita	ISO 10545-3	EN 14411 annex G (Group Bla) EN 14411 appendice G (Gruppo Bla)			ISO 13006 annex G (Group Bla) ISO 13006 appendice G (Gruppo Bla)	≤ 0,5% Individual Maximum 0,6% - ≤ 0,5% Valore massimo singolo 0,6%
		ASTM C373	Requirement ANSI A137.1 Water Absorption Max ≤ 0,5% ± 0,5%				≤ 0,5 %
Bulk mechanical characteristics	Breaking strength Sforzo di rottura	ISO 10545-4	S ≥ 1300 N			S ≥ 1500 N	
		ISO 10545-4	R ≥ 35 N/mm²			R ≥ 40 N/mm²	
Bulk mechanical characteristics	Modulus of rupture Resistenza alla flessione	ISO 10545-5	Declared value Dichiarare un valore	Test method available Metodo di prova disponibile	≥ 0,55		
		ISO 10545-5	Declared value Dichiarare un valore	Test method available Metodo di prova disponibile	≥ 0,55		
Surface mechanical characteristics	Impact resistance, as coefficient of restitution Resistenza all'impatto, espresso come coefficiente di restituzione	ISO 10545-5	Declared value Dichiarare un valore	Test method available Metodo di prova disponibile	≥ 0,55		
		ISO 10545-6	≤ 175 mm³			≤ 150 mm³	
Thermal and hygrometric characteristics	Coefficient of thermal linear expansion Coefficiente di dilatazione termica lineare	ISO 10545-8	Declared value Dichiarare un valore	Test method available Metodo di prova disponibile	≤ 7 MK ⁻¹		
		ISO 10545-9	Pass according to ISO 10545-1 Test superato in accordo con ISO 10545-1	Test method available Metodo di prova disponibile	Resistant Resiste		
Thermal and hygrometric characteristics	Thermal shock resistance Resistenza agli sbalzi termici	ISO 10545-9	Pass according to ISO 10545-1 Test superato in accordo con ISO 10545-1	Test method available Metodo di prova disponibile	Resistant Resiste		
		ISO 10545-10	Declared value Dichiarare un valore	Test method available Metodo di prova disponibile	≤ 0,01% (0,1mm/m)		
Thermal and hygrometric characteristics	Moisture expansion (in mm/m) Dilatazione all'umidità (in mm/m)	ISO 10545-10	Declared value Dichiarare un valore	Test method available Metodo di prova disponibile	≤ 0,01% (0,1mm/m)		
		ISO 10545-12	Pass according to ISO 10545-1 Test superato in accordo con ISO 10545-1	Required Metodo di prova richiesto	Resistant Resiste		
Physical properties	Frost resistance Resistenza al gelo	ISO 10545-12	Pass according to ISO 10545-1 Test superato in accordo con ISO 10545-1	Required Metodo di prova richiesto	Resistant Resiste		
		EN 12004-2	Declared value Dichiarare un valore	-	≥ 1,0 N/mm² (Class C2 - EN 12004)		
Physical properties	Reaction to fire Reazione al fuoco	-	Class A1 or A1 _s Classe A1 oppure A1 _s	-	A1 - A1 _s		
		ISO 10545-13	Declared value Dichiarare una Classe	Manufacturer is to state classification Secondo la classificazione indicata dal fabbricante	LA		
Chemical characteristics	Resistance to low concentrations of acids and alkalis Resistenza a basse concentrazioni di acidi e alcali	ISO 10545-13	Declared value Dichiarare una Classe	Manufacturer is to state classification Secondo la classificazione indicata dal fabbricante	LA		
		ISO 10545-13	Declared value Dichiarare una Classe	Declared value Dichiarare una Classe	HA		
Chemical characteristics	Resistance to high concentrations of acids and alkalis Resistenza ad alte concentrazioni di acidi e alcali	ISO 10545-13	Declared value Dichiarare una Classe	Declared value Dichiarare una Classe	HA		
		ISO 10545-14	Declared value Dichiarare una Classe	Declared value Dichiarare una Classe	5		
Safety characteristics (*)	Resistance to staining, for unglazed tiles Resistenza alle macchie per piastrelle non smaltate	ISO 10545-14	Declared value Dichiarare una Classe	Declared value Dichiarare una Classe	5		
		DIN EN 16165 ANNEX B (EX DIN 51130)	Declared value Dichiarare un valore	-	R11 Boost, Boost Mix, Boost Balance, Boost Mineral, Boost Natural, Boost Pro, Boost Stone, Exence, Lims, Log Select, Marvel T, Marvel Travertine, Norde, Nyra		
Safety characteristics (*)	Shod Ramp Test Metodo della rampa "calzato"	DIN EN 16165 ANNEX B (EX DIN 51130)	Declared value Dichiarare un valore	-	R11 Boost, Boost Mix, Boost Balance, Boost Mineral, Boost Natural, Boost Pro, Boost Stone, Exence, Lims, Log Select, Marvel T, Marvel Travertine, Norde, Nyra		
		DIN EN 16165 ANNEX A (EX DIN 51097)	Declared value Dichiarare un valore	-	A+B+C Boost, Boost Balance, Boost Mineral, Boost Mix, Boost Natural, Boost Pro, Boost Stone, Boost Vision, Exence, Lims, Log Select, Marvel T, Marvel Travertine, Norde, Nyra		
Safety characteristics (*)	Barefoot Ramp Test Metodo della rampa a piedi nudi	DIN EN 16165 ANNEX A (EX DIN 51097)	Declared value Dichiarare un valore	-	A+B+C Boost, Boost Balance, Boost Mineral, Boost Mix, Boost Natural, Boost Pro, Boost Stone, Boost Vision, Exence, Lims, Log Select, Marvel T, Marvel Travertine, Norde, Nyra		
		BS EN 16165 ANNEX C (EX BS 7976)	Declared value Dichiarare un valore	-	PVT > 36 Dry PVT > 36 Wet		
Safety characteristics (*)	Pendulum Friction Test Metodo del Pendolo	AS 4586	Declared Classification of the pedestrian surface materials according to the Wet Pendulum Test			Class ≥ P4	
		UNE EN 16165 ANNEX C (EX UNE 41901 EX:2017)	Declared value Dichiarare un valore	-	Class C3		
Safety characteristics (*)	Coefficient of friction (COF) Coefficiente di attrito	B.C.R.A. Rep. CEC/81	D. M. 236/89 del 14/06/89 μ > 0,40 per elemento scivolante gomma dura su pavimentazione bagnata μ > 0,40 per elemento scivolante cuoio su pavimentazione asciutta			> 0,40 Asciutto > 0,40 Bagnato	
		ANSI A 326.3	-	-	> 0,55 Wet		

(*) Anti-slip performance is guaranteed at the time of delivery of the product. Le prestazioni anti-slip vengono garantite al momento della consegna del prodotto.
 (*) The permissible deviation, in % or mm, of the average size for each tile (2 or 4 sides) from work size (W). Deviazione ammissibile, in % oppure mm, della dimensione media di ogni piastrella (2 oppure 4 lati) dalla dimensione di fabbricazione (W).
 (**) The permissible deviation, in % or mm, of the average thickness for each tile from the work size thickness (W). Deviazione ammissibile, in % oppure mm, dello spessore medio di ogni piastrella dallo spessore riportato nella dimensione di fabbricazione (W).
 (***) The maximum permissible deviation from straightness, in % or mm, related to the corresponding work sizes (W). Deviazione massima ammissibile di rettilineità, in % oppure mm, in rapporto alle dimensioni di fabbricazione (W) corrispondenti.
 (****) The maximum permissible deviation from rectangularity, in % or mm, related to the corresponding work sizes (W). Deviazione massima ammissibile di ortogonalità, in % oppure mm, in rapporto alle dimensioni di fabbricazione (W) corrispondenti.
 c.c. The maximum permissible deviation from centre curvatures, in % or mm, related to diagonal calculated from the work sizes (W). Deviazione massima ammissibile della curvatura del centro, in % oppure mm, in rapporto alla diagonale calcolata secondo le dimensioni di fabbricazione (W).
 e.c. The maximum permissible deviation from edge curvatures, in % or mm, related to the corresponding work sizes (W). Deviazione massima ammissibile della curvatura dello spigolo, in % oppure mm, in rapporto alle dimensioni di fabbricazione (W) corrispondenti.
 w. The maximum permissible deviation from warpage, in % or mm, related to diagonal calculated from the work sizes (W). Deviazione massima ammissibile dello svergolamento, in % oppure mm, in rapporto alla diagonale calcolata secondo le dimensioni di fabbricazione (W).

INDEX



SIZE INDEX



SURFACE RANGE



IMAGE GALLERY



PRODUCT RANGE



TECHNICAL SPECIFICATIONS



Recommendations for raised installation

Raccomandazioni per la posa sopraelevata . Empfehlungen für die Verlegung als Doppelboden . Conseils pour la pose surélevée . Recomendaciones para la colocación sobreelevada . Рекомендации по укладке в виде фальшпола

Tiles requiring the application of the double glass-fiber net can be supplied with proper backing by Atlas Concorde. For prices of the application of the reinforcements (steel sheet and double fiberglass mesh) and of the installation accessories (pedestals, spacers, clips, etc.) see the "Atlas Concorde Outdoor Accessories" price list on MyAtlas.

Le piastrelle che richiedono l'applicazione di doppia rete in fibra di vetro sono fornite con la necessaria lavorazione da Atlas Concorde. Relativamente ai prezzi dell'applicazione dei rinforzi (foglio di acciaio e doppia rete in fibra di vetro) e degli accessori di posa (supporti, distanziatori, clip, ...) si rimanda al listino "Accessori Outdoor Atlas Concorde" disponibile su MyAtlas.

Fliesen, für die die Anwendung eines doppelten Glasfasernetz notwendig ist, werden mit dieser Bearbeitung durch Atlas Concorde geliefert. Die Preise der verstärkten Ausführungen (Stahlblatt und doppeltes Glasfasernetz) sowie der Verlege Utensilien (Träger, Distanzstücke, Clips...) finden Sie in der Preisliste „Outdoor-Zubehör Atlas Concorde“ in MyAtlas.

Les carreaux qui exigent l'application d'un double treillis en fibre de verre sont fournis avec le traitement nécessaire réalisé par Atlas Concorde. En ce qui concerne les prix de l'application des renforts (feuille d'acier et double filet en fibre de verre) et les accessoires de pose (supports, entretoises, clips, etc.), nous vous prions de consulter le catalogue "Accessoires d'extérieur Atlas Concorde" disponible sur MyAtlas.

Las baldosas que requieren la aplicación de una red doble de fibra de vidrio son entregadas por Atlas Concorde con la elaboración necesaria. Para los precios de aplicación de los refuerzos (chapa de acero y doble malla de fibra de vidrio) y de los accesorios de instalación (soportes, distanciadores, clips, etc.), véase la lista de "Accesorios de Exteriores Atlas Concorde" disponible en MyAtlas.

Плитки, требующие приклеивания двойной стекловолоконной сетки, поставляются с соответствующей обработкой Atlas Concorde. Цены на упрочняющие элементы (стальной лист, двойная стекловолоконная сетка) и на аксессуары (опоры, распорки, кляммеры и т.д.) приведены в прайс-листе «Аксессуары для наружной укладки», доступном в MyAtlas.

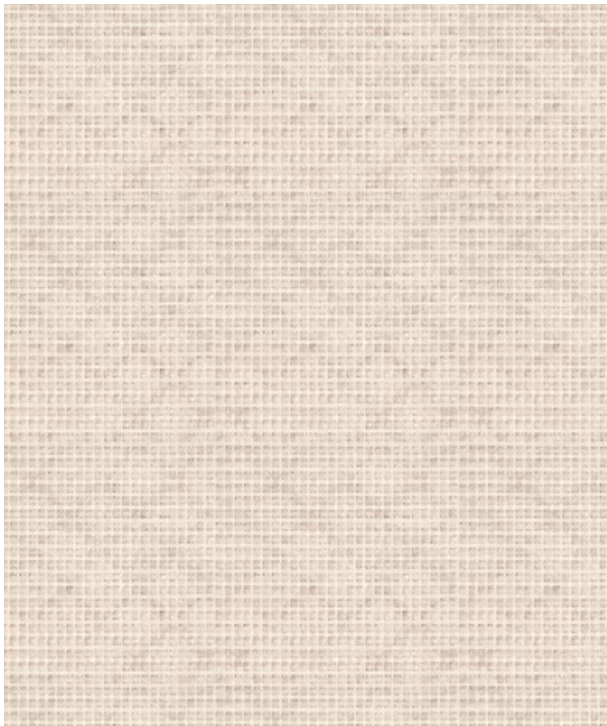

Warning: outdoor pavings installed unglued above the ground level are subject to the action of the wind, with the risk, in some cases, of becoming airborne. The manufacturer recommends to require the assistance of a qualified professional in order to check the suitability of the installation system above the ground adopted, in accordance with the local laws and regulations and the conditions of use. Failure to do so could result in serious injury or property damage. A ceramic slab installed on a raised pedestal system may fracture on impact if a heavy object is dropped onto it from a height, with a risk of injury to anyone standing or walking on such slab. Failure to adhere to the manufacturer's instructions for installation of slabs on raised pedestal systems may result in serious injury.

Attenzione: Le pavimentazioni da esterno posate a secco in quota sono soggette all'azione del vento, con il rischio di sollevamento delle lastre. Il produttore raccomanda di far verificare l'idoneità del sistema di posa in quota da un tecnico abilitato in base alla normativa locale vigente ed alle condizioni d'uso, al fine di evitare il rischio di danni a persone e cose. Una lastra ceramica posata su un sistema sopraelevato può rompersi per impatto qualora un oggetto pesante cada sulla stessa da una certa altezza, con il rischio di seri danni per chiunque possa sostare o transitare sulla piastrella stessa. Il mancato rispetto delle istruzioni fornite dal produttore relative alla posa su sistemi sopraelevati può provocare seri danni alla persona.

Warnung: Bodenbeläge die trocken im aussenbereich in der höhe verlegt werden, unterliegen der wirkung des windes, wodurch die gefahr besteht, dass die platten aufgeworfen werden. Der hersteller erteilt daher die empfehlung, dass die eignung des systems für eine verlegung in der höhe durch einen zugelassenen sachverständigen überprüft wird, wobei die lokal gültigen vorschriften und nutzungsbedingungen zu beachten sind, um die gefahr von personen- und sachschäden zu vermeiden. Eine keramikplatte die auf einem doppelbodensystem verlegt ist, kann durch den aufprall eines aus einer bestimmten höhe herabfallenden gegenstandes zerbrechen. Hier besteht das risiko schwerer verletzungen für all jene die auf der fliese gehen, oder stehen. Bei nichtberücksichtigung der vom hersteller vorgegebenen verlegevorschriften für doppelbodensysteme, kann es zu schwerwiegenden verletzungen der personen kommen.

Avertissement : les dallages extérieurs posés sans collage sont soumis à l'action du vent, avec le risque de soulèvement des plaques, notamment ceux posés aux étages d'un bâtiment. Le fabricant recommande de faire vérifier par un technicien qualifié la bonne adaptation du système de pose en étages avec la réglementation en vigueur et les conditions d'utilisation locales, afin d'éviter le risque de dommages aux personnes et aux biens. Une dalle céramique posée sur un système surélevé peut se casser à la suite d'un impact d'un objet lourd qui y chuterait d'une certaine hauteur, avec le risque de sérieux dommages pour quiconque stationnerait ou transiterait sur ce carreau. Le non respect des instructions fournies par le fabricant relatives à la pose sur des systèmes surélevés peut provoquer de sérieux dommages aux personnes.

Atención: las pavimentaciones de exteriores colocadas en seco en altura están sometidas a la acción del viento, con el riesgo del levantamiento de las losas. El productor aconseja hacer verificar la idoneidad del sistema de colocación en altura por un técnico calificado en base a la normativa local vigente y a las condiciones de uso, a fin de evitar el riesgo de daños a personas y cosas. Una losa cerámica colocada sobre un sistema elevado puede romperse producto de un impacto en caso de que un objeto pesado caiga sobre ella desde una cierta altura, con el riesgo de serios daños para cualquiera que pueda detenerse o pasar sobre dicha baldosa. No respetar las instrucciones entregadas por el fabricante respecto de la colocación sobre sistemas sobreelevados puede provocar serios daños a las personas.

Внимание: Уличные покрытия, уложенные бесклеевым способом на опоры, подвержены воздействию ветра и, как следствие, риску подъема или отрыва плиток. Поэтому, во избежание травмирования людей или повреждения имущества, система укладки для соответствующих условий эксплуатации и ее соответствие местным нормам и правилам должны быть проверены квалифицированным специалистом. Падение тяжелого предмета с большой высоты может повлечь за собой разлом уложенной на опоры плитки с риском получения травмы для того, кто находится на плитке. Несоблюдение инструкций производителя по укладке на опоры может стать причиной серьезного травмирования.

	H UP TO ¾" (2cm)	H FROM ¾" (2cm) TO 4" (10cm)	H FROM 4" (10cm) TO 12" (30cm)
	H FINO A 2 CM H BIS 2 CM JUSQU'À 2 CM HASTA 2 CM ДО 2 CM	H DA 2 CM A 10 CM H VON 2 BIS 10 CM DE 2 A 10 CM DA 2 CM A 10 CM 2-10 CM	H DA 10 CM A 30 CM H VON 10 BIS 30 CM DE 10 A 30 CM DA 10 CM A 30 CM 10-30 CM
	4 supports (3,4 pcs/m ²) 4 supporti (3,4 pz/m ²) 4 Träger (3,4 St/m ²) 4 supports (3,4 pc/m ²) 4 pedestales (3,4 pz/m ²) 4 опор (3,4 шт./м ²)	4 supports (3,4 pcs/m ²) 4 supporti (3,4 pz/m ²) 4 Träger (3,4 St/m ²) 4 supports (3,4 pc/m ²) 4 pedestales (3,4 pz/m ²) 4 опор (3,4 шт./м ²)	4 supports double glass-fibre net (3,4 pcs/m ²) 4 supporti + doppia rete in fibra di vetro (3,4 pz/m ²) 4 Träger + doppeltes Glasfasernetz (3,4 St/m ²) 4 supports + double treillis fibre de verre (3,4 pc/m ²) 4 pedestales + doble red de fibra de vidrio (3,4 pz/m ²) 4 опор + двойная стекловолоконная сетка (3,4 шт./м ²)
	6 supports (4,8 pcs/m ²) 6 supporti (4,8 pz/m ²) 6 Träger (4,8 St/m ²) 6 supports (4,8 pcs/m ²) 6 pedestales (4,8 pz/m ²) 6 опор (4,8 шт./м ²)	6 supports (4,8 pcs/m ²) double glass-fibre net 6 supporti + doppia rete in fibra di vetro (4,8 pz/m ²) 6 Träger + doppeltes Glasfasernetz (4,8 St/m ²) 6 supports + double treillis fibre de verre (4,8 pz/m ²) 6 pedestales + doble red de fibra de vidrio (4,8 pz/m ²) 6 опор + двойная стекловолоконная сетка (4,8 шт./м ²)	6 supports (4,8 pcs/m ²) double glass-fibre net 6 supporti + doppia rete in fibra di vetro (4,8 pz/m ²) 6 Träger + doppeltes Glasfasernetz (4,8 St/m ²) 6 supports + double treillis fibre de verre (4,8 pc/m ²) 6 pedestales + doble red de fibra de vidrio (4,8 pz/m ²) 6 опор + двойная стекловолоконная сетка (4,8 шт./м ²)
	4 supporti (2 pz/m ²) 4 Träger (2 St/m ²) 4 supports (2 pcs/m ²) 4 pedestales (2 pz/m ²) 4 опор (2 шт./м ²)	4 supporti + doppia rete in fibra di vetro (2 pz/m ²) 4 Träger + doppeltes Glasfasernetz (2 St/m ²) 4 supports + double treillis fibre de verre (2 pz/m ²) 4 pedestales + doble red de fibra de vidrio (2 pz/m ²) 4 опор + двойная стекловолоконная сетка (2 шт./м ²)	4 supporti + doppia rete in fibra di vetro (2 pz/m ²) 4 Träger + doppeltes Glasfasernetz (2 St/m ²) 4 supports + double treillis fibre de verre (2 pcs/m ²) 4 pedestales + doble red de fibra de vidrio (2 pz/m ²) 4 опор + двойная стекловолоконная сетка (2 шт./м ²)
	6 supports (7,0 pcs/m ²) 6 supporti (7,0 pz/m ²) 6 Träger (7,0 St/m ²) 6 supports (7,0 pc/m ²) 6 pedestales (7,0 pz/m ²) 6 опор (7,0 шт./м ²)	6 supports (7,0 pcs/m ²) double glass-fibre net 6 supporti + doppia rete in fibra di vetro (7,0 pz/m ²) 6 Träger + doppeltes Glasfasernetz (7,0 St/m ²) 6 supports + double treillis fibre de verre (7,0 pc/m ²) 6 pedestales + doble red de fibra de vidrio (7,0 pz/m ²) 6 опор + двойная стекловолоконная сетка (7,0 шт./м ²)	6 supports double glass-fibre net (7,0 pcs/m ²) 6 supporti + doppia rete in fibra di vetro (7,0 pz/m ²) 6 Träger + doppeltes Glasfasernetz (7,0 St/m ²) 6 supports + double treillis fibre de verre (7,0 pc/m ²) 6 pedestales + doble red de fibra de vidrio (7,0 pz/m ²) 6 опор + двойная стекловолоконная сетка (7,0 шт./м ²)
	6 supports (3,4 pcs/m ²) 6 supporti (3,4 pz/m ²) 6 Träger (3,4 St/m ²) 6 supports (3,4 pcs/m ²) 6 pedestales (3,4 pcs/m ²) 6 опор (3,4 шт./м ²)	6 supports (3,4 pcs/m ²) double glass-fibre net 6 supporti + doppia rete in fibra di vetro (3,4 pz/m ²) 6 Träger + doppeltes Glasfasernetz (3,4 St/m ²) 6 supports + double treillis fibre de verre (3,4 pcs/m ²) 6 pedestales + doble red de fibra de vidrio (3,4 pcs/m ²) 6 опор + двойная стекловолоконная сетка (3,4 шт./м ²)	6 supports double glass-fibre net (3,4 pcs/m ²) 6 supporti + doppia rete in fibra di vetro (3,4 pz/m ²) 6 Träger + doppeltes Glasfasernetz (3,4 St/m ²) 6 supports + double treillis fibre de verre (3,4 pcs/m ²) 6 pedestales + doble red de fibra de vidrio (3,4 pcs/m ²) 6 опор + двойная стекловолоконная сетка (3,4 шт./м ²)
	8 supports (2,7 pcs/m ²) 8 supporti (2,7 pz/m ²) 8 Träger (2,7 St/m ²) 8 supports (2,7 pcs/m ²) 8 pedestales (2,7 pcs/m ²) 8 опор (2,7 шт./м ²)	8 supports (2,7 pcs/m ²) double glass-fibre net 8 supporti + doppia rete in fibra di vetro (2,7 pz/m ²) 8 Träger + doppeltes Glasfasernetz (2,7 St/m ²) 8 supports + double treillis fibre de verre (2,7 pcs/m ²) 8 pedestales + doble red de fibra de vidrio (2,7 pcs/m ²) 8 опор + двойная стекловолоконная сетка (2,7 шт./м ²)	8 supports double glass-fibre net (2,7 pcs/m ²) 8 supporti + doppia rete in fibra di vetro (2,7 pz/m ²) 8 Träger + doppeltes Glasfasernetz (2,7 St/m ²) 8 supports + double treillis fibre de verre (2,7 pcs/m ²) 8 pedestales + doble red de fibra de vidrio (2,7 pcs/m ²) 8 опор + двойная стекловолоконная сетка (2,7 шт./м ²)

Any damaged parts must be replaced immediately. Before installing any outdoor surface, the slope to be applied to the pavement should be carefully assessed according to the project requirements and intended use.
 È necessario sostituire immediatamente i pezzi eventualmente danneggiati. Prima della realizzazione di ogni superficie in esterno occorre valutare con attenzione la pendenza necessaria da applicare alla pavimentazione in funzione delle esigenze di progetto e della destinazione d'uso. Eventuali schadhafte Fliesen sind sofort zu ersetzen. Vor der Verlegung jeglichen Außenbelags ist das notwendige, dem Boden zuverleihende Gefälle sorgfältig auf Grundlage der Projektanforderungen und der Zweckbestimmung zu definieren. Il est nécessaire de remplacer immédiatement toutes les pièces qui seraient éventuellement endommagées. Avant de réaliser la pose de carreaux en extérieur, il faut évaluer attentivement la pente nécessaire à appliquer au dallage en fonction des exigences du projet et de la destination d'usage. Cualquier pieza dañada debe sustituirse inmediatamente. Antes de realizar una superficie de exterior, es necesario evaluar cuidadosamente la inclinación necesaria a aplicar al pavimento en función de los requisitos del proyecto y del uso previsto.
 Поврежденные плитки должны быть немедленно заменены. Перед укладкой плитки на улице необходимо внимательно рассчитать уклон покрытия с учетом его функционального назначения и требований проекта.

NORTH AMERICA AND OCEANIA MARKET SPECIFICATION

UP TO ¾" (2cm)	ABOVE ¾" (2cm)
FINO A 2 CM ¾"/2"	OLTRE AI 2CM ¾"/2"
BIS 2 CM	UBER 2 CM
JUSQU'À 2 CM - ¾"/2"	AU-DELÀ DE 2 CM - ¾"/2"
HASTA 2 CM - ¾"/2"	MÁS DE 2 CM - ¾"/2"
ДО 2 CM	БОЛЕЕ 2 CM
4 supports (0,32 pcs/sq ft)	please contact your Atlas Concorde sales representative
4 supporti (0,32 pz/m ²)	contattare il referente commerciale Atlas Concorde
4 Träger (0,32 St/m ²)	bitte kontaktieren sie den handelsvertreter von Atlas Concorde
4 support (0,32 pcs/m ²)	contacter le représentant d'Atlas Concorde
4 pedestales (0,32 pzas/m ²)	ponerse en contacto con el agente de Atlas Concorde
4 опор (0,32 шт./м ²)	обратитесь к представителю Atlas Concorde
6 supports (0,48 pcs/sq ft)	please contact your Atlas Concorde sales representative
6 supporti (0,48 pz/m ²)	contattare il referente commerciale Atlas Concorde
6 Träger (0,48 St/m ²)	bitte kontaktieren sie den handelsvertreter von Atlas Concorde
6 supports (0,48 pcs/m ²)	contacter le représentant d'Atlas Concorde
6 pedestales (0,48 pzas/m ²)	ponerse en contacto con el agente de Atlas Concorde
6 опор (0,48 шт./м ²)	обратитесь к представителю Atlas Concorde
4 supports (0,2 pcs/sq ft)	please contact your Atlas Concorde sales representative
4 supporti (0,2 pz/m ²)	contattare il referente commerciale Atlas Concorde
4 Träger (0,2 St/m ²)	bitte kontaktieren sie den handelsvertreter von Atlas Concorde
4 support (0,2 pcs/m ²)	contacter le représentant d'Atlas Concorde
4 pedestales (0,2 pzas/m ²)	ponerse en contacto con el agente de Atlas Concorde
4 опор (0,2 шт./м ²)	обратитесь к представителю Atlas Concorde
6 supports (0,65 pcs/sq ft)	please contact your Atlas Concorde sales representative
6 supporti (0,65 pz/m ²)	contattare il referente commerciale Atlas Concorde
6 Träger (0,65 St/m ²)	bitte kontaktieren sie den handelsvertreter von Atlas Concorde
6 support (0,65 pcs/m ²)	contacter le représentant d'Atlas Concorde
6 pedestales (0,65 pzas/m ²)	ponerse en contacto con el agente de Atlas Concorde
6 опор (0,65 шт./м ²)	обратитесь к представителю Atlas Concorde
6 supports (0,32 pcs/sq ft)	please contact your Atlas Concorde sales representative
6 supporti (0,32 pz/m ²)	contattare il referente commerciale Atlas Concorde
6 Träger (0,32 St/m ²)	bitte kontaktieren sie den handelsvertreter von Atlas Concorde
6 support (0,32 pcs/m ²)	contacter le représentant d'Atlas Concorde
6 pedestales (0,32 pzas/m ²)	ponerse en contacto con el agente de Atlas Concorde
6 опор (0,32 шт./м ²)	обратитесь к представителю Atlas Concorde
8 supports (0,27 pcs/sq ft)	please contact your Atlas Concorde sales representative
8 supporti (0,27 pz/m ²)	contattare il referente commerciale Atlas Concorde
8 Träger (0,27 St/m ²)	bitte kontaktieren sie den handelsvertreter von Atlas Concorde
8 support (0,27 pcs/m ²)	contacter le représentant d'Atlas Concorde
8 pedestales (0,27 pzas/m ²)	ponerse en contacto con el agente de Atlas Concorde
8 опор (0,27 шт./м ²)	обратитесь к представителю Atlas Concorde

INDEX



SIZE INDEX



SURFACE RANGE



IMAGE GALLERY



PRODUCT RANGE



TECHNICAL SPECIFICATIONS



Packing

Imballi . Verpackung . Packaging . Packaging . Упаковка

	Pieces x box Pezzi x scatola Stück pro Karton Pièces par boîte Piezas por caja Штук в коробке	M² x box M² x scatola M² pro Karton M² par boîte M² por caja Кв.м в коробке	Boxes x pallet Scatole x pallet Kartons pro Palette Boîtes par palette Cajas por pallet Коробок на поддоне	Kg x box Kg x scatola Kg pro Karton Kg par boîte Kg por caja кг в коробке	M² x pallet M² x pallet M² pro Palette M² par palette M² por pallet Кв.м на поддоне	Kg x pallet Kg x pallet Kg pro Palette Kg par palette Kg por pallet кг в поддоне
± 20 mm						
60x60	2	0,72	30	33,00	21,60	990,00
80x80	1	0,64	42	29,70	26,88	1.247,40
60x90	2	1,08	24	48,50	25,92	1.149
30x120	2	0,72	36	33,00	25,92	1.188,00
60x120	1	0,72	35	33,35	25,20	1.167,25
120x120	1	1,44	20	67,66	28,80	1.353,20
± 9 mm						
30x60	7	1,26	40	24,85	50,40	994,00
60x60	3	1,080	40	21,57	43,20	862,8
60x120	2	1,44	35	30,00	50,40	1.050,00
80x80	2	1,28	48	26,6	61,44	1.276,8
18,5x150	4	1,11	40	23,68	44,40	947,20
120x120	2	2,88	20	58,00	57,60	1.160,00
20x120	6	1,44	32	31,10	46,08	995,2



INDEX



SIZE INDEX



SURFACE RANGE



IMAGE GALLERY



PRODUCT RANGE



TECHNICAL SPECIFICATIONS





INDEX



SIZE INDEX



SURFACE
RANGE



IMAGE GALLERY



PRODUCT RANGE



TECHNICAL
SPECIFICATIONS





Ceramiche Atlas Concorde S.p.A.
Via Canaletto 141
41042 Spezzano di Fiorano (MO) - Italia

Copyright 2025 by Ceramiche Atlas Concorde S.p.A
(41042 Spezzano di Fiorano (MO) - Italia)
January 2026



atlasconcorde.com