

YŌKO

WOW



YŌKO

Yoko, a common Japanese name with a poetic meaning related to nature and the sea, inspires the new collection that celebrates the delicacy and fragility of the art of origami. A technique that leads us to a state of calm and concentration, stimulating our creativity.

The decorations in this series, inspired by paper folds, combined with crystalline glazes, achieve lighter shades on the edges of each piece. The colors, reminiscent of traditional Japanese ceramics, are connected to nature, from the green of the trees, the blue of the sea, to the brown of the earth.

Yoko, nombre común japonés con un significado poético relacionado con la naturaleza y el mar, inspira la nueva colección que ensalza la delicadeza y fragilidad del arte del origami. Técnica que nos lleva a un estado de calma y concentración, estimulando nuestra creatividad.

Los decorados de esta serie inspirados por los pliegues en el papel, y junto a los esmaltes cristalinos, conseguimos tonalidades más claras en las aristas de la pieza. Los colores, como en la cerámica tradicional japonesa, se relacionan con la naturaleza, desde el verde de los árboles, el azul del mar y el marrón de la tierra.

01. SIZES, COLOURS AND FINISHES / FORMATOS, COLORES Y ACABADOS	<i>pag. 4</i>
02. GET INSPIRED / INSPIRATE	<i>pag. 6</i>
04. TECHNICAL FEATURES / CARACTERÍSTICAS TÉCNICAS	<i>pag. 24</i>
05. PACKING	<i>pag. 25</i>
06. PRICE CODE / CÓDIGO DE TARIFA	<i>pag. 25</i>
07. TECHNICAL DRAWINGS / DIBUJOS TÉCNICOS	<i>pag. 26</i>
08. RECOMMENDATIONS / RECOMENDACIONES	<i>pag. 27</i>



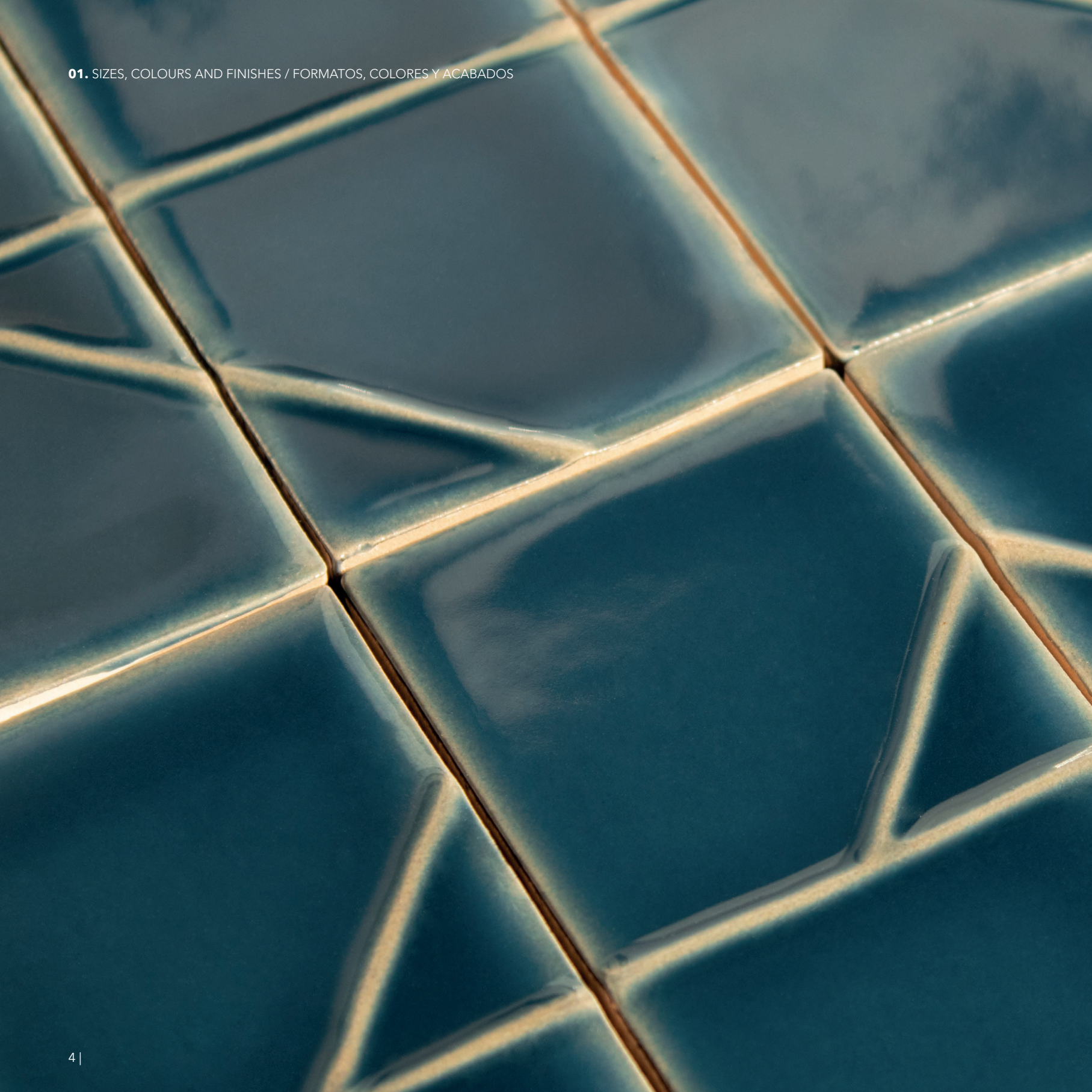

YŌKO 6,2x12,5 cm / 2.5"x5"

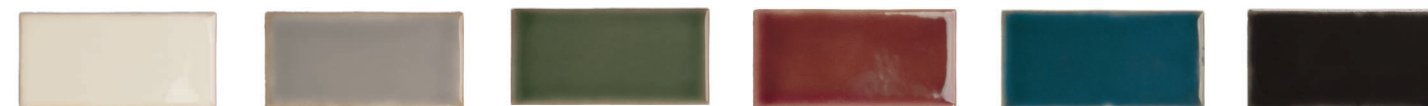

Daisy Pewter Moss Bordo Marine Onyx

ORIGAMI 6,2x12,5 cm / 2.5"x5"

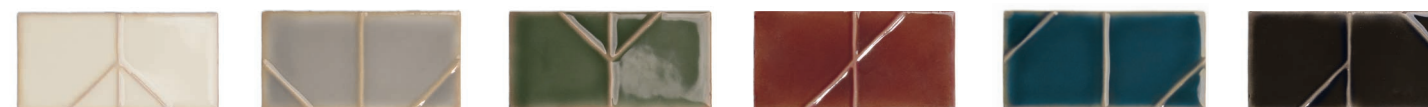

Daisy Pewter Moss Bordo Marine Onyx

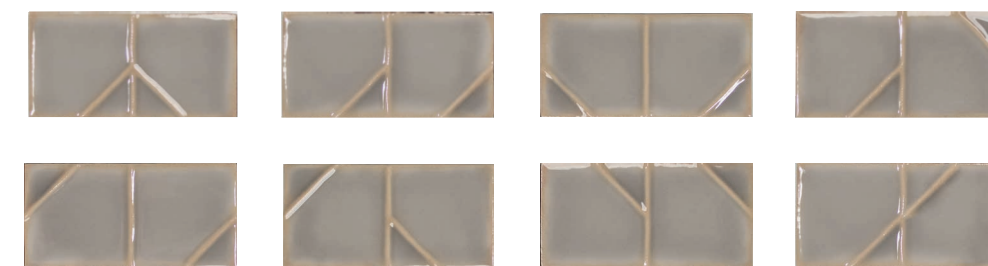

* 8 different patterns randomly mixed within the box / * 8 diseños diferentes encajados aleatoriamente

YOKO ROUNDED EDGE 1,1x12,5 cm / 0.43"x5"



* Available in all Yōko Colours
* Disponible en todos los colores de Yōko



Yoko Daisy
Origami Daisy

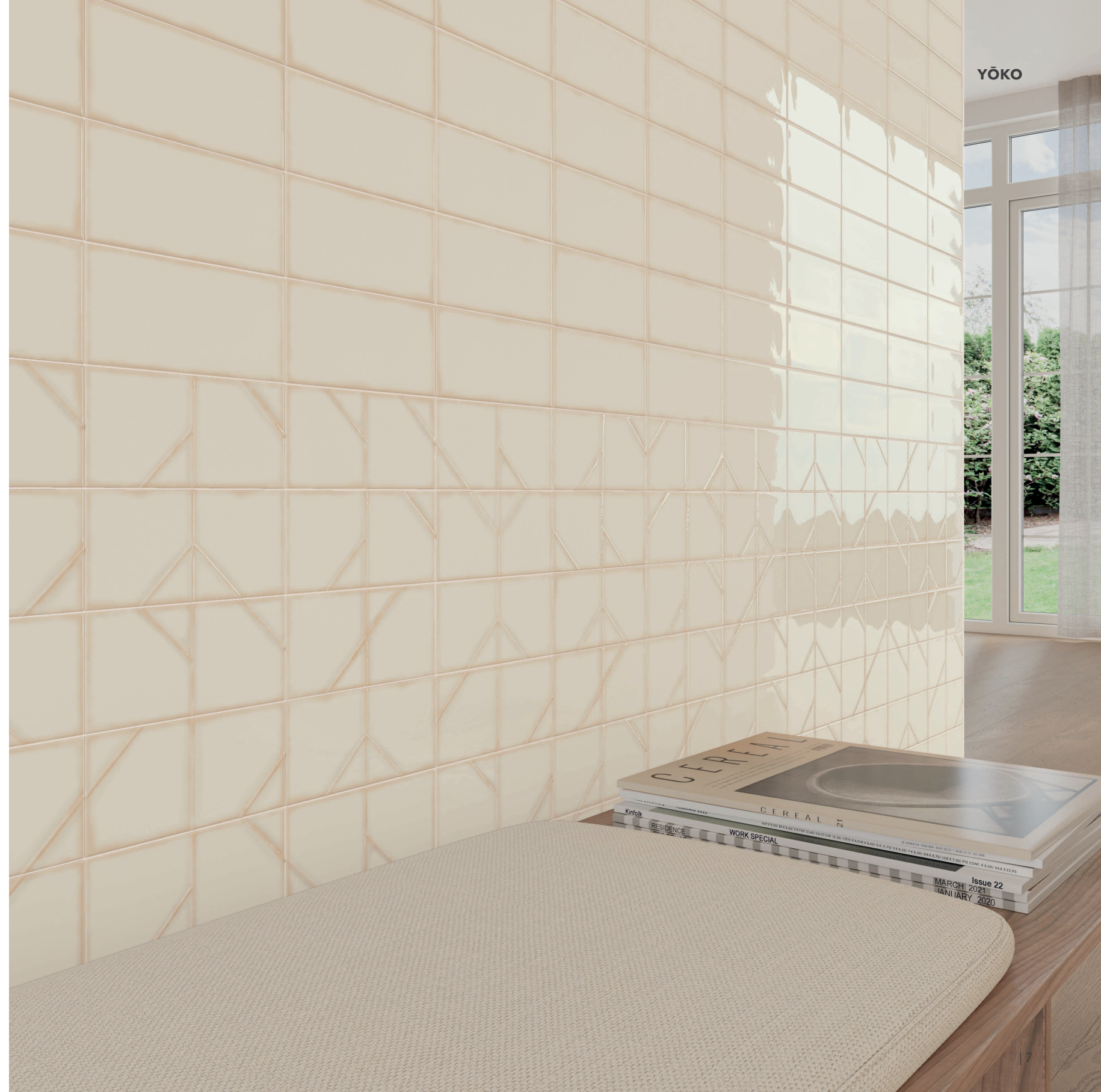



Yōko Moss
Origami Moss

Floor: Raster Lines S Ash & Lines M Ash (Raster Collection)



Yōko Daisy
Wall: Origami Pewter



Yōko Marine 70%
Origami Marine 30%

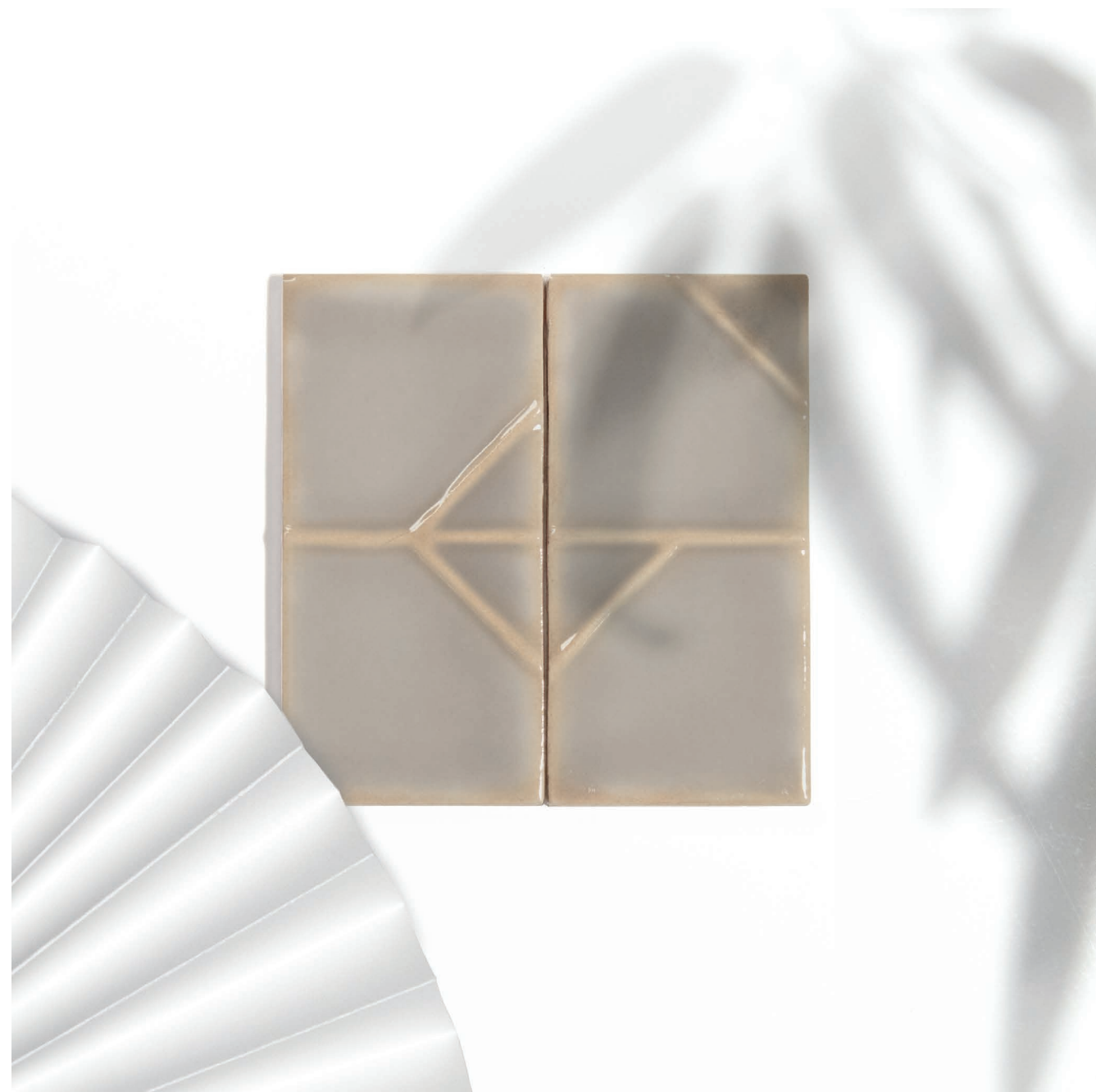

Yōko Pewter 80%
Origami Pewter 20%
Yōko Rounded Edge Pewter



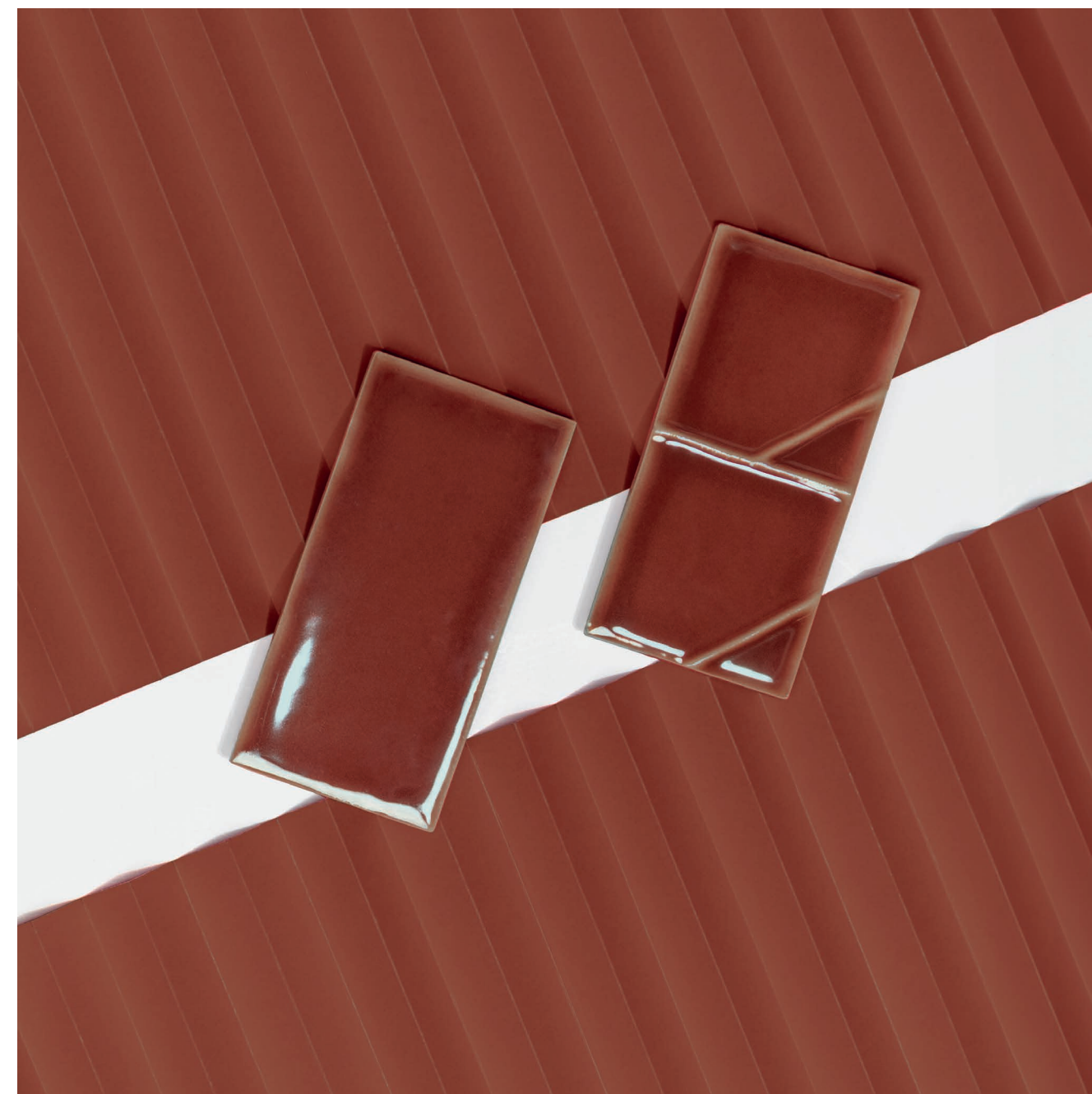

Yöko Bordo 80%
Origami Bordo 20%



Yoko Onyx 33,33%
Origami Onyx 66,66%

Floor: Yakedo Sand (Ensō Collection)



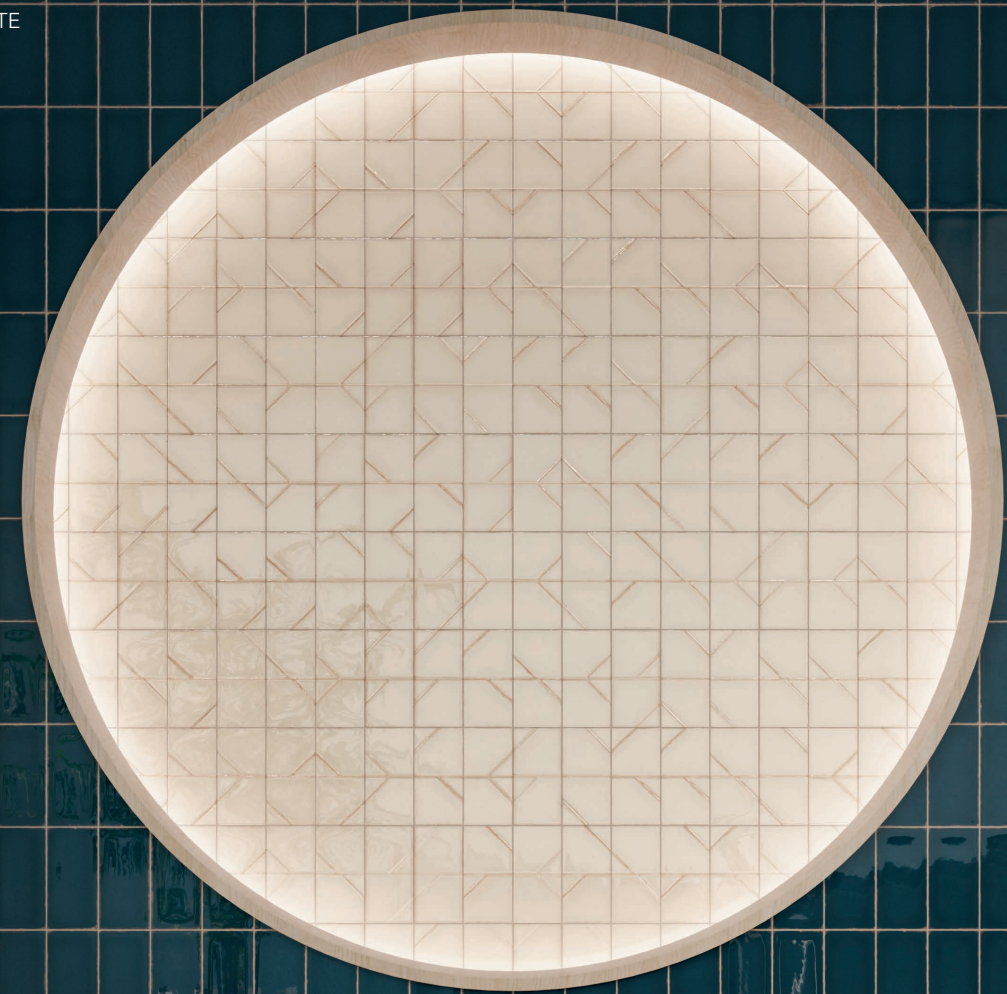

Yōko Marine
Origami Daisy

Floor: Tanka Graphite (Ensō Collection)











Yōko Bordo 60%
Origami Bordo 40%

Floor: Abbey Stone XXL Rila (Abbey Stone Collection)















04. TECHNICAL FEATURES / INFORMACIÓN TÉCNICA

Technical features for Dry-Pressed ceramic tiles with water absorption BIII (Eb >10%)
 Características técnicas para las baldosas cerámicas prensadas en seco del grupo BIII (Eb >10%)

FEATURES / CARACTERÍSTICAS	SPECIFICATION / ESPECIFICACIÓN	NORMA
 Dimensional Features	<p>Yōko 62,0 mm +/- 0,75 mm x 125,0 mm +/- 0,75 mm</p> <p>Origami 62,0 mm +/- 0,75 mm x 125,0 mm +/- 0,75 mm</p>	UNE-EN ISO 10545-2:2019
 Water absorption	$E_b > 10\%$	UNE-EN ISO 10545-3:2018
 Modulus of rupture and breaking strength	$\geq 12 \text{ N/mm}^2$ $\geq 600 \text{ N}$	UNE-EN ISO 10545-4:2019
 Crazing resistance	Pass	UNE-EN ISO 10545-11:1997
 Household products resistance	GA	UNE-EN ISO 10545-13:2017
 Chemical resistance	GHA	UNE-EN ISO 10545-13:2017
 Stain resistance	Class 5	UNE-EN ISO 10545-14:2017
 Tone variation	V2	-
 White body	-	-

05. PACKING

			KG 	M2 		M2 
Modelo	Formato (cm)	Piezas / Caja	Kg / Caja	m2 / Caja	Cajas / Palet	m2 / Palet
YŌKO	6,2x12,5 cm	76	7,84 kg	0,594 m ²	102	60,588 m ²
ORIGAMI	6,2x12,5 cm	72	7,79 kg	0,563 m ²	102	57,426 m ²
ROUNDED EDGE	1,1x12,5 cm	20	0,40 kg	2,480 m	200	496 m

			LB 	FT2 		FT2 
Model	Format (in)	Pieces / Box	Lb/ box	sq ft / Box	Boxes / Pallet	sq ft / Pallet
YŌKO	2.5"x5"	76	17.284 lb	6.393 ft ²	102	652.163 ft ²
ORIGAMI	2.5"x5"	72	17.174 lb	6.06 ft ²	102	618.128 ft ²
ROUNDED EDGE	0.43"x5"	20	8.818 lb	8.136 ft	200	1627.2 ft

06. PRICE CODE

MODEL / MODELO	PRICE CODE / CODIGO TARIFA
YŌKO	W18
ORIGAMI	W21
ROUNDED EDGE	WS3

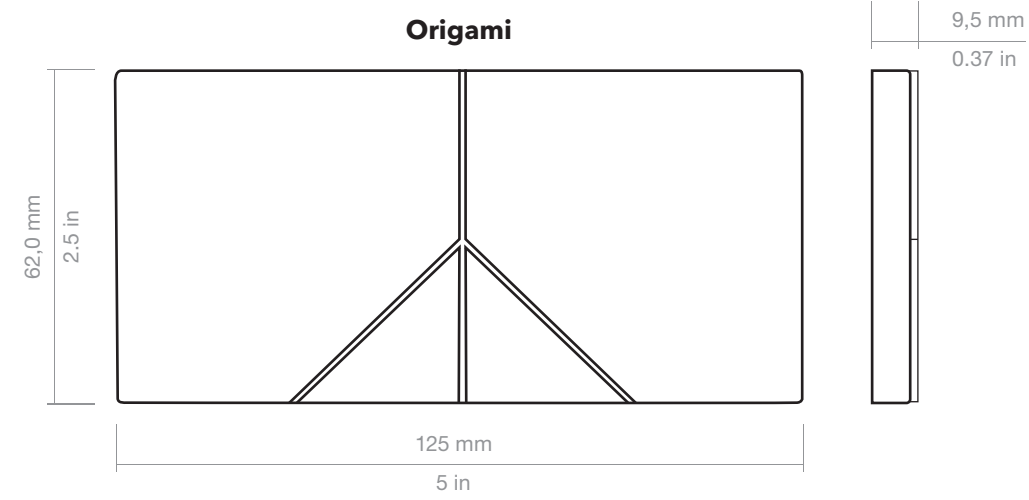
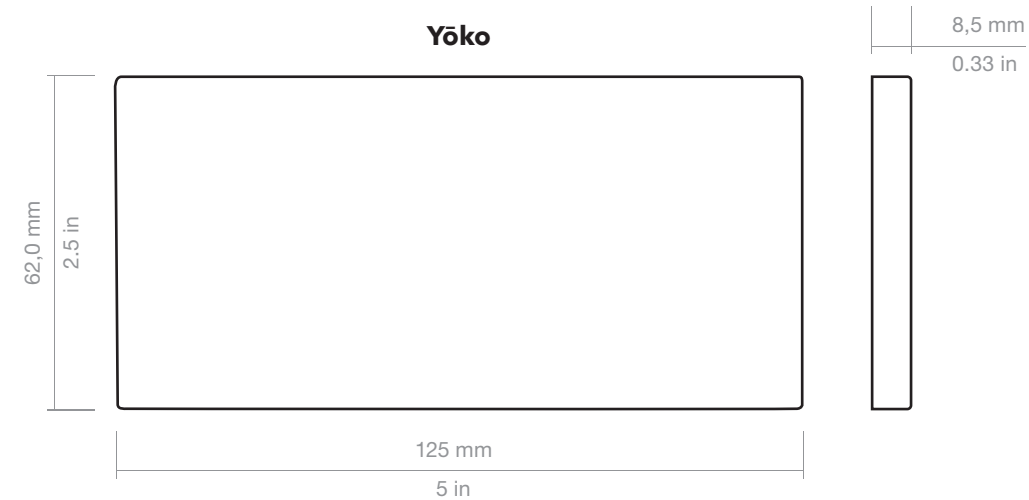

BEFORE INSTALLING THE PRODUCT

The surface where the product is being installed must be clean and level.
 It is recommended that the layout of the product is prepared before the final installation.
 Make sure you choose an adhesive apt for the area where the product is being installed.
 For installation on porous surfaces we recommend: Kerakoll Special® Eco, and for Non-porous surfaces: Kerakoll serie H40® Eco.

The choice of quality grouting mortar is crucial.
 We recommend Kerakoll Fugabella® Color.
 (www.kerakoll.com)

TO ENHANCE YOUR WOW PRODUCT

In order to obtain the maximum WOW effect, use 1,5 mm - 0.06 in spacers between the tiles to maintain an even installation over the whole surface.
 The following grout colors are recommended for each of the references: Fugabella 39 - Daisy and Bordo; Fugabella 26 - Moos, Onyx and Pewter; Fugabella 44 - Marine.
 Once the area has been grouted, and before the grout dries, remove any excess material with a damp sponge.

MAINTENANCE

Maintenance free. Easy and practical to care for, due to the high standard of technical characteristics in each WOW ceramic product.
 Avoid abrasive or acidic cleaning products.
 It is recommended to clean with clear water.

ANTES DE LA COLOCACIÓN

Preparar la superficie sobre la que se va a colocar tu producto WOW. Debe estar limpia y aplomada.
 Se recomienda plantear la colocación, previo a su instalación.
 Elegir el material de agarre en función de las características de la superficie.
 Se recomienda para colocación general en superficies porosas: Kerakoll special® Eco, y para superficies no porosas como el pladur: Kerakoll serie H40® Eco.

Es importante la elección de un material de rejunte de calidad. WOW recomienda utilizar el material de rejunte Kerakoll fugabella® Color (www.kerakoll.com), cuyas características son especialmente adecuadas para este revestimiento.

PARA ENSALZAR EL ASPECTO DE TU PRODUCTO WOW

Se recomiendan separadores de 1,5 mm para colocar las piezas y conseguir de esta forma un aspecto WOW óptimo.
 Se aconsejan los siguientes colores de rejuntado para cada una de las referencias: Fugabella 39 - Daisy y Bordo; Fugabella 26 - Moss, Onyx y Pewter; Fugabella 44 - Marine.
 Una vez rejuntado el producto, y antes de que se endurezca, retirar el material sobrante de rejuntado con una esponja mojada en agua.

MANTENIMIENTO

Práctico y sencillo de limpiar, dadas las excelentes características técnicas del producto WOW, tan sólo es necesario un cuidado rutinario, evitando la utilización de productos abrasivos o ácidos.
 Se recomienda limpiar exclusivamente con agua limpia.

Designed by



Polígono Pont, Avda. de España 114
12180 Cabanes,
Castellón (Spain)
t. +34 964 331 910 / f. +34 964 331 911

wowdesigneu.com
comercial@wowdesigneu.com

©2024 Tendencias Cerámicas

WOW, registered trademark of Tendencias Cerámicas, S.L.

The brand use or reproduction of the contents of this catalog, is protected by copyright law. Any use of the brand or reproduction thereof, in part or total, must be authorized by Tendencias Cerámicas, S.L. Otherwise, this action can be sanctioned according to the Law.

©2024 Tendencias Cerámicas

WOW, marca registrada por Tendencias Cerámicas, S.L.

La utilización de la marca o la reproducción del contenido de este catálogo está protegida por la Ley de Propiedad Intelectual. Cualquier uso de la marca o la reproducción del mismo, en parte o en su totalidad, debe ser autorizada por Tendencias Cerámicas, S.L., pudiendo, en caso contrario, ser esta acción sancionada de acuerdo con la Ley.

WOW reserves the right to modify and/or discontinue certain models displayed in this catalogue.

The colour of the pieces displayed herein may differ slightly from originals.

The settings shown in this catalogue are design proposals for advertising purposes.

In real situations in which the pieces are laid, the installation instructions published by WOW should be followed.

WOW se reserva el derecho de modificar y/o suprimir ciertos modelos expuestos en este catálogo sin previo aviso.

Los colores de las piezas pueden presentar ligeras diferencias respecto a las originales.

Los ambientes que se muestran en este catálogo son sugerencias decorativas de carácter publicitario, debiéndose utilizar en la instalación real las instrucciones de colocación editadas por WOW.





www.wowdesigneu.com